

WORK POSITIONERS



**SMART
LIFTING
SOLUTIONS**

Edmo Lift  www.edmolift.se





Table of contents

Introduction	4
Application areas	7
More than a product a solution	9
Our ergonomic solutions	10
Range of tools	12
Range of trolleys	26
Trolley WP ONE	30
Trolley WP 55	32
Trolley WP 55 SS	36
Trolley WP 65	40
Trolley WP 65 SS	44
Trolley WP 85	48
Trolley WP 85 SS	54
Trolley WP 125	60
Trolley WP 125 SS	66
Trolley WP 205	72
Trolley WP 205 SS	78
Trolley WP 285	84
Trolley WP 285 SS	88

INTRODUCTION

In this catalogue, you'll find WP lifters and tools designed by Reglift for optimum handling.

GENERAL AND CONTACT INFORMATION

E-mail: b2b@edmolift.se
 Tel.no: +46 (0)611-36 87 00
 Fax.no: +46 (0)611-511 580

PRICING AND SHIPPING INFORMATION

To find out the price of each reference, please refer to the price list provided or get in touch with your sales contact. For your information, all prices are in euros and ex works.

SHIPPING TIME

4 weeks	Standard trolleys (without options) + standard tools.
8 weeks	Trolleys with options and/or customizable tools.
10 weeks	Trolleys with standard electric tools.
14 weeks	Trolleys with special tools.

* Excluding WP 285, in standard version, 8 weeks, and 14-16 weeks with an electric tool

HOW TO READ OUR TROLLEYS REFERENCES

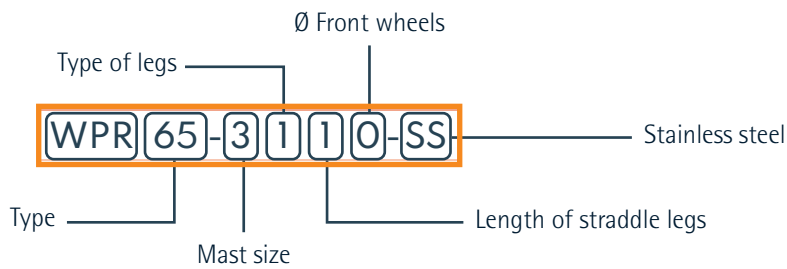

Mast	Type of legs	Length of straddle	Front wheels
0			75
1	XS	ST	80
2	S	CEN	
3	M	AN	
4	L		

TECHNICAL GUIDELINES

Please consider all the following guidelines when using the catalogue and configuring your solution.

OPTIONS TROLLEYS		
WPR-O-0003	2 Additional AGM battery	This option must be added when using electric tools on WP 125.
WPR-O-0007	1 Additional Electric function	When using electric tools or accessories refs: WPR-T-0031-SS / WPR-A-0027-SS, please add option WPR-O-0007.
WPR-O-0008	2 Additional Electric function	When using electric tool WPR-T-0030-SS / WPR-T-0032-SS / WPR-T-0037, please add option WPR-O-0008.
WPR-O-0010-SS	Lateral rollers for tool holder carriage	This option must be added for all tools with tilting and rotation, and when the center of gravity of the loads is offset of + 200 mm from the mast on one side. We reserve the right to add this option to your order if we deem necessary.
WPR-O-0012 to WPR-O-0015	Legs enlargement	Please consider +/- 5 mm of the given dimensions for options WPR-O-0012 to WPR-O-0015 version Steel and SS.
WPR-O-0019	Mast Height custom fit	For special mast height, consider a mast higher than your requirement to apply this option. Example: if you require a special height of 2000 mm, take a lifting trolley with mast L + option WPR-O-0019.
WPR-O-0026 & WPR-O-0026-SS	Swivelling front wheel Ø 75 mm - for WP 205* & for WP 205-SS	With option WPR-O-0026 added to a WP 205, the max capacity of the trolley is 150 kg.

TOOLS AND ACCESSORIES	
* For all customisable tools => see loads diagram of the trolleys for lifting capacity.	
* For all customisable tools => please provide dimensions and drawings of the loads.	
* Please use tools WPR-0030-SS / WPR-0031-SS / WPR-0032-SS & accessory WPR-A-0027-SS only with legs length 650 mm.	
* Please use tools WPR-T-0030-SS / WPR-T-0031-SS / WPR-T-0032-SS / WPR-T-0037 & accessory WPR-A-0027-SS only with legs length 650 mm.	
* Please use WPR-A-0021-SS / WPR-A-0022-SS / WPR-A-0023-SS only for solid and compact load.	
* Please use WPR-A-9024-SS for soft load with potential deformation.	





- ÖPPEN
- Bitte nicht überlasten!
1. Klemmenkasten
 2. Hochspannung
 3. Metallteile
 4. Klemmen
 5. Metallteile
 6. Metallteile
 7. Metallteile
 8. Metallteile
 9. Metallteile
 10. Metallteile
 11. Metallteile
 12. Metallteile
 13. Metallteile
 14. Metallteile
 15. Metallteile
 16. Metallteile
 17. Metallteile
 18. Metallteile
 19. Metallteile
 20. Metallteile
- Bitte nicht überlasten!

APPLICATION AREAS



AGRI-FOOD INDUSTRY



MEDICAL



INDUSTRY



LOGISTIC



PHARMACEUTIC



RETAIL INDUSTRY

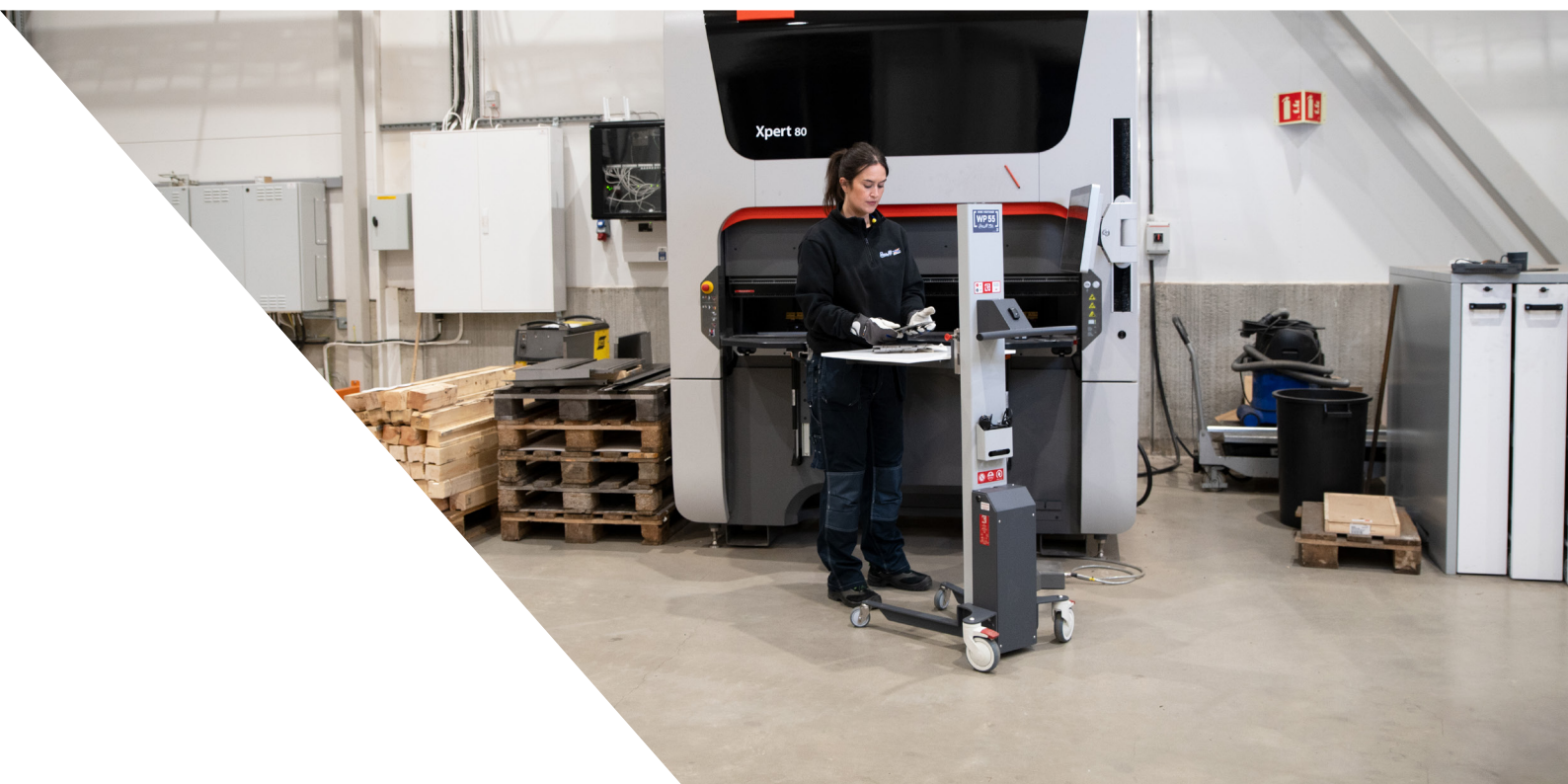



WP 125

MORE THAN A PRODUCT

A SOLUTION

Material

- Steel: IP44
- Stainless steel (304L): IP65

Tool holder

- Houses a wide range of manual and power tools
- Quick change system
- Anti-crush system

Braking system

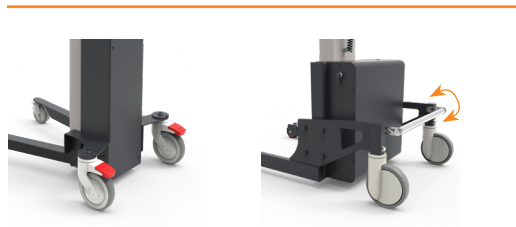

- 2 options: individual or central

Wheels

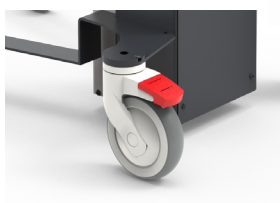

- Fixed and free wheels at the front and the rear
- ESD



- Ergonomic multiposition handle: Ergo Control®
- Fixed or mobile remote control
- 8 possible configurations

Battery

- AGM or Lithium

Legs

- Modular design in length and width
- 3 leg configurations



OUR ERGONOMIC SOLUTIONS

We aim to provide the best Ergonomic Solutions for your handling operations, and we offer a wide range of tools which are especially designed to help operators in their daily processes and reduce the MSDs risks at work by improving the safety and comfort for the operators while maintaining productivity in all your production operations.

You can find a perfectly adapted solution in our large choice of standard and customizable lifting tools, from the platform or boom to lift boxes or reels up and down, to the multifunction electric tool which can grip, rotate, and position your loads accurately into your machines.

All our tools or solutions are suitable for various types of working and industrial environments from administration offices to food or chemical factories.

With more than 25 years of experience in contact with many different situations, applications, and environments, we are able to customize our solutions for your unique handling needs, we provide an adapted design of our solutions to fit your handling operations.





SCAN CODE

RANGE OF TOOLS

BOOMS

BOOM WITH WHEEL + V-SUPPORT 360°



FRAME MATERIAL	STEEL			STAINLESS STEEL		
Reference	WPR-T-0001			WPR-T-0001-SS		
Length in mm	500			500		
Width in mm	300			300		
Weight in kg	6			6		
COMPATIBLE	WP 55	WP 65	WP 85	WP 125	WP 205	WP 285
Capacity in kg	50	60	80	80	80	-

BOOM WITH WHEEL FOR V-SUPPORT



FRAME MATERIAL	STEEL	CUSTOMISABLE STEEL *		STAINLESS STEEL	CUSTOMISABLE STAINLESS STEEL *	
Reference	WPR-T-0002	WPR-T-9002		WPR-T-0002-SS	WPR-T-9002-SS	
Length in mm	500	300 - 800		500	300 - 800	
Width in mm	60	60		60	60	
Weight in kg	2,5	-		2,5	-	
COMPATIBLE	WP 55	WP 65	WP 85	WP 125	WP 205	WP 285
Capacity in kg	50	60	80	80	80	-

V-SUPPORT



FRAME MATERIAL	STEEL	CUSTOMISABLE STEEL *		STAINLESS STEEL	CUSTOMISABLE STAINLESS STEEL *	
Reference	WPR-T-0003	WPR-T-9003		WPR-T-0003-SS	WPR-T-9003-SS	
Length in mm	350	200-600		350	200-600	
Width in mm	300	300		300	300	
Weight in kg	3	-		3	-	
COMPATIBLE	WP 55	WP 65	WP 85	WP 125	WP 205	WP 285
Capacity in kg	50	60	80	80	80	-

BOOM - TUBE Ø 60



FRAME MATERIAL	STEEL	CUSTOMISABLE STEEL *		STAINLESS STEEL	CUSTOMISABLE STAINLESS STEEL *	
Reference	WPR-T-0004	WPR-T-9004		WPR-T-0004-SS	WPR-T-9004-SS	
Length in mm	500	300-1000		500	300-1000	
Width in mm	60	60		60	60	
Weight in kg	3	-		3	-	
COMPATIBLE	WP 55	WP 65	WP 85	WP 125	WP 205	WP 285
Capacity in kg	50	60	80	120	120	-

BOOM - TUBE Ø 35



FRAME MATERIAL	CUSTOMISABLE STEEL *			CUSTOMISABLE STAINLESS STEEL *		
Reference	WPR-T-9005			WPR-T-9005-SS		
Length in mm	300-800			300-800		
Width in mm	35			35		
Weight in kg	-			-		
COMPATIBLE	WP 55	WP 65	WP 85	WP 125	WP 205	WP 285
Capacity in kg	50	60	80	80	80	-

BEARING BOOM

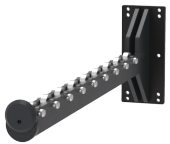

FRAME MATERIAL	CUSTOMISABLE STEEL *			CUSTOMISABLE STAINLESS STEEL *		
Reference	WPR-T-9035			WPR-T-9035-SS		
Length in mm	300-800			300-800		
Width in mm	-			-		
Weight in kg	-			-		
COMPATIBLE	WP 55	WP 65	WP 85	WP 125	WP 205	WP 285
Capacity in kg	50	60	80	120	180	-

DOUBLE BOOM - TUBE Ø 35



FRAME MATERIAL	STEEL	CUSTOMISABLE STEEL *		STAINLESS STEEL	CUSTOMISABLE STAINLESS STEEL *	
Reference	WPR-T-0006	WPR-T-9006		WPR-T-0006-SS	WPR-T-9006-SS	
Length in mm	500	200-800		500	200-800	
Width in mm	330	100-600		330	100-600	
Weight in kg	5	-		5	-	
COMPATIBLE	WP 55	WP 65	WP 85	WP 125	WP 205	WP 285
Capacity in kg	50	60	80	110	110	-

BOOM ACCESSORIES

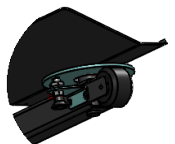

REFERENCE	DESCRIPTION	TOOLS COMPATIBILITY
WPR-A-0028-SS	Rotation indexing system with 90° locking by indexable finger Accessory for V platform Material: Stainless steel	Boom with wheel (steel) Ref: WPR-T-0001 / WPR-T-0002 / WPR-T-9002

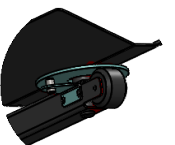

WPR-A-0029-SS	Rotation indexing system with 90° locking by ball screw Accessory for V platform Material: stainless steel	Boom with wheel (stainless steel) Ref: WPR-T-0001-SS / WPR-T-0002-SS / WPR-T-9002-SS
---------------	--	---

RANGE OF TOOLS

PLATFORMS

PLATFORM STAINLESS STEEL - 60 KG

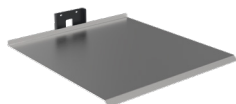

FRAME MATERIAL	STEEL			STAINLESS STEEL		
Reference	WPR-T-0007			WPR-T-0007-SS		
Length in mm	500			500		
Width in mm	500			500		
Weight in kg	7			7		
COMPATIBLE	WP 55	WP 65	WP 85	WP 125	WP 205	WP 285
Capacity in kg	50	60	60	60	60	-

PLATFORM STAINLESS STEEL - 85 KG

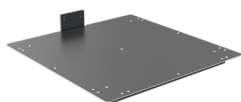

FRAME MATERIAL	STEEL	CUSTOMISABLE STEEL *	STAINLESS STEEL	CUSTOMISABLE STAINLESS STEEL *		
Reference	WPR-T-0008	WPR-T-9008	WPR-T-0008-SS	WPR-T-9008-SS		
Length in mm	500	200-700	500	200-700		
Width in mm	500	200-700	500	200-700		
Weight in kg	8,1	-	8,1	-		
COMPATIBLE	WP 55	WP 65	WP 85	WP 125	WP 205	WP 285
Capacity in kg	45	55	75	85	85	-

PLATFORM STAINLESS STEEL - 200 KG

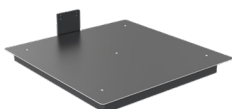

FRAME MATERIAL	STEEL	CUSTOMISABLE STEEL *	STAINLESS STEEL	CUSTOMISABLE STAINLESS STEEL *		
Reference	WPR-T-0009	WPR-T-9009	WPR-T-0009-SS	WPR-T-9009-SS		
Length in mm	500	300-600	500	300-600		
Width in mm	500	300-600	500	300-600		
Weight in kg	11,7	-	11,7	-		
COMPATIBLE	WP 55	WP 65	WP 85	WP 125	WP 205	WP 285
Capacity in kg	-	-	-	110	190	200

PLATFORM HDPE - 60 KG

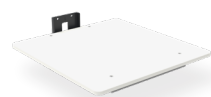

FRAME MATERIAL	STEEL			STAINLESS STEEL		
Reference	WPR-T-0010			WPR-T-0010-SS		
Length in mm	500			500		
Width in mm	500			500		
Weight in kg	5			5		
COMPATIBLE	WP 55	WP 65	WP 85	WP 125	WP 205	WP 285
Capacity in kg	50	60	60	60	60	-

PLATFORM HDPE - 85 KG

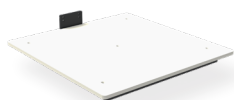

FRAME MATERIAL	STEEL	CUSTOMISABLE STEEL *	STAINLESS STEEL	CUSTOMISABLE STAINLESS STEEL *		
Reference	WPR-T-0011	WPR-T-9011	WPR-T-0011-SS	WPR-T-9011-SS		
Length in mm	500	200-700	500	200-700		
Width in mm	500	200-700	500	200-700		
Weight in kg	7	-	7	-		
COMPATIBLE	WP 55	WP 65	WP 85	WP 125	WP 205	WP 285
Capacity in kg	50	60	80	85	85	-

PLATFORM HDPE WITH ROLLS - 85 KG



FRAME MATERIAL	STEEL	STAINLESS STEEL				
Reference	WPR-T-0012	WPR-T-0012-SS				
Length in mm	500	500				
Width in mm	500	500				
Weight in kg	10	10				
COMPATIBLE	WP 55	WP 65	WP 85	WP 125	WP 205	WP 285
Capacity in kg	45	55	75	85	85	-

PLATFORM HDPE - 200 KG

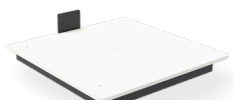

FRAME MATERIAL	STEEL	CUSTOMISABLE STEEL *	STAINLESS STEEL	CUSTOMISABLE STAINLESS STEEL *		
Reference	WPR-T-0013	WPR-T-9013	WPR-T-0013-SS	WPR-T-9013-SS		
Length in mm	500	300-600	500	300-600		
Width in mm	500	300-600	500	300-600		
Weight in kg	11	-	11	-		
COMPATIBLE	WP 55	WP 65	WP 85	WP 125	WP 205	WP 285
Capacity in kg	-	-	-	110	190	200

WAVE PLATFORM

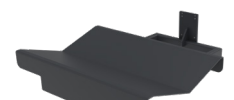

FRAME MATERIAL	STEEL	STAINLESS STEEL				
Reference	WPR-T-0014	WPR-T-0014-SS				
Length in mm	400	400				
Width in mm	600	600				
Weight in kg	14	14				
COMPATIBLE	WP 55	WP 65	WP 85	WP 125	WP 205	WP 285
Capacity in kg	-	50	70	80	80	-

RANGE OF TOOLS

▶ PLATFORMS

WAVE PLATFORM WITH ROLLERS



FRAME MATERIAL	CUSTOMISABLE STEEL *			CUSTOMISABLE STAINLESS STEEL *		
Reference	WPR-T-9039			WPR-T-9039-SS		
Length in mm	800			800		
Width in mm	550			550		
Weight in kg	25			25		
COMPATIBLE	WP 55	WP 65	WP 85	WP 125	WP 205	WP 285
Capacity in kg	-	-	-	100	160	160

BOOM ACCESSORIES PLATFORM

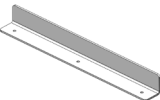
	REFERENCE	DESCRIPTION	TOOLS COMPATIBILITY
	WPR-A-0015-SS	Platform rollers Ø 50 mm with 2 fixation pieces SS Rollers length: 300/400/500/600 mm	All Platform
	WPR-A-0016-SS	Platform edges - SS Length: 330/430/530 mm	All Platform

CRANE - 200 KG

FRAME MATERIAL	STEEL	CUSTOMISABLE STEEL *	STAINLESS STEEL	CUSTOMISABLE STAINLESS STEEL *		
Reference	WPR-T-0015	WPR-T-9015	WPR-T-0015-SS	WPR-T-9015-SS		
Length in mm	600	200-1000	600	200-1000		
Width in mm	400	200-600	400	200-600		
Weight in kg	6	-	6	-		
COMPATIBLE	WP 55	WP 65	WP 85	WP 125	WP 205	WP 285
Capacity in kg	45	55	75	115	195	200

CRANE ACCESSORIES

REFERENCE	DESCRIPTION	TOOLS COMPATIBILITY
 WPR-A-0007-SS	Weighting system for crane Capacity: 200 kg Accuracy: +/- 0,1 kg Digital display Battery powered Material: Stainless steel 304 L	Cranes Ref: WPR-T-0015 / WPR-T-9015 / WPR-T-0015-SS / WPR-T-9015-SS
 WPR-A-0009-SS	Snap Hook Ø 6 - SS Capacity: 300 kg	Cranes Ref: WPR-T-0015 / WPR-T-9015 / WPR-T-0015-SS / WPR-T-9015-SS
 WPR-A-0010-SS	Snap Hook Ø 8 - SS Capacity: 800 kg	Cranes Ref: WPR-T-0015 / WPR-T-9015 / WPR-T-0015-SS / WPR-T-9015-SS
 WPR-A-0011-SS	Lifting chain (1 m) - SS price for 1 meter Capacity: 900 kg	Cranes Ref: WPR-T-0015 / WPR-T-9015 / WPR-T-0015-SS / WPR-T-9015-SS
 WPR-A-0012	Safety shackle Capacity: 500 kg	Cranes Ref: WPR-T-0015 / WPR-T-9015 / WPR-T-0015-SS / WPR-T-9015-SS
 WPR-A-0012-SS	Safety shackle - SS Capacity: 500 kg	Cranes Ref: WPR-T-0015 / WPR-T-9015 / WPR-T-0015-SS / WPR-T-9015-SS
 WPR-A-0013	Latch hook Capacity: 1120 kg	Cranes Ref: WPR-T-0015 / WPR-T-9015 / WPR-T-0015-SS / WPR-T-9015-SS

RANGE OF TOOLS

CRANE ACCESSORIES

	REFERENCE	DESCRIPTION	TOOLS COMPATIBILITY
	WPR-A-0013-SS	Latch hook - SS Capacity: 900 kg	Cranes Ref: WPR-T-0015 / WPR-T-9015 / WPR-T-0015-SS / WPR-T-9015-SS
	WPR-A-0014	360° Latch hook Capacity: 1120 kg	Cranes Ref: WPR-T-0015 / WPR-T-9015 / WPR-T-0015-SS / WPR-T-9015-SS
	WPR-A-0019	Adjustable crane crossbar 60 x 40 Length 600 mm Capacity: 200 kg Material: Steel painted RAL 7024 Fixation of the cross bar adjustable on the crane 2 adjustable fixation points for the lifting accessories LIFTING ACCESSORIES NOT INCLUDING	Cranes Ref: WPR-T-0015 / WPR-T-9015 / WPR-T-0015-SS / WPR-T-9015-SS
	WPR-A-9019	Adjustable crane crossbar 60 x 40 - Customizable Length: 200-800 mm Capacity: 150 kg Material: Steel painted RAL 7024 Fixation of the cross bar adjustable on the crane 2 adjustable fixation points for the lifting accessories LIFTING ACCESSORIES NOT INCLUDING	Cranes Ref: WPR-T-0015 / WPR-T-9015 / WPR-T-0015-SS / WPR-T-9015-SS
	WPR-A-0019-SS	Adjustable crane crossbar 60 x 40 Length: 600 mm Capacity: 200 kg Material: Stainless steel 304 L Fixation of the cross bar adjustable on the crane 2 adjustable fixation points for the lifting accessories LIFTING ACCESSORIES NOT INCLUDING	Cranes Ref: WPR-T-0015 / WPR-T-9015 / WPR-T-0015-SS / WPR-T-9015-SS
	WPR-A-9019-SS	Adjustable crane crossbar 60x40 - Customizable Length: 200-800 mm Capacity: 150 kg Material: Stainless steel 304 L Fixation of the cross bar adjustable on the crane 2 adjustable fixation points for the lifting accessories LIFTING ACCESSORIES NOT INCLUDING	Cranes Ref: WPR-T-0015 / WPR-T-9015 / WPR-T-0015-SS / WPR-T-9015-SS

FORKS

FORK - 160 KG

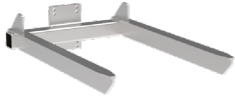

FRAME MATERIAL	CUSTOMISABLE STEEL *			CUSTOMISABLE STAINLESS STEEL *		
Reference	WPR-T-9016			WPR-T-9016-SS		
Length in mm	300-800			300-800		
Width in mm	300-800			300-800		
Weight in kg	-			-		
COMPATIBLE	WP 55	WP 65	WP 85	WP 125	WP 205	WP 285
Capacity in kg	45	55	75	115	160	-

ADJUSTABLE FORK - 650 MM - 85 KG



FRAME MATERIAL	STEEL			STAINLESS STEEL		
Reference	WPR-T-0018			WPR-T-0018-SS		
Length in mm	610			610		
Width in mm	300-675			300-675		
Weight in kg	12			12		
COMPATIBLE	WP 55	WP 65	WP 85	WP 125	WP 205	WP 285
Capacity in kg	40	50	70	85	85	-

REINFORCED ADJUSTABLE FORK - 650 MM - 160 KG

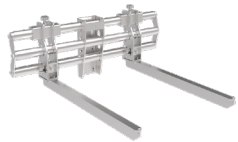

FRAME MATERIAL	STEEL	CUSTOMISABLE STEEL *		STAINLESS STEEL	CUSTOMISABLE STAINLESS STEEL *	
Reference	WPR-T-0033	WPR-T-9033**		WPR-T-0033-SS	WPR-T-9033-SS**	
Length in mm	650	100-800		650	100-800	
Width in mm	300-675	300-1000		300-675	300-1000	
Weight in kg	16	-		16	-	
COMPATIBLE	WP 55	WP 65	WP 85	WP 125	WP 205	WP 285
Capacity in kg	-	-	-	110	120** - 160	-

SYMMETRIC ADJUSTABLE FORK - 180 KG



FRAME MATERIAL	CUSTOMISABLE STEEL *			CUSTOMISABLE STAINLESS STEEL *		
Reference	WPR-T-9019			WPR-T-9019-SS		
Length in mm	-			-		
Width in mm	-			-		
Weight in kg	25			25		
COMPATIBLE	WP 55	WP 65	WP 85	WP 125	WP 205	WP 285
Capacity in kg	-	50	70	110	180	-

**Capacity for customisable tools

*Please refer to page 5 of this catalogue for the technical guidelines.

RANGE OF TOOLS

FORKS

4 CLEAT FORKS



FRAME MATERIAL	CUSTOMISABLE STAINLESS STEEL *					
Reference	WPR-T-9020-SS					
Length in mm	300 - 600					
Width in mm	-					
Weight in Kg	-					
COMPATIBLE	WP 55	WP 65	WP 85	WP 125	WP 205	WP 285
Capacity in Kg	-	55	75	100	100	-

8 CLEAT FORKS



FRAME MATERIAL	CUSTOMISABLE STAINLESS STEEL *					
Reference	WPR-T-9021-SS					
Length in mm	300-800					
Width in mm	-					
Weight in kg	-					
COMPATIBLE	WP 55	WP 65	WP 85	WP 125	WP 205	WP 285
Capacity in kg	-	50	70	100	140	-

8 CLEAT FORKS - ADJUSTABLE



FRAME MATERIAL	CUSTOMISABLE STAINLESS STEEL *					
Reference	WPR-T-9038-SS					
Length in mm	300-800					
Width in mm	-					
Weight in kg	-					
COMPATIBLE	WP 55	WP 65	WP 85	WP 125	WP 205	WP 285
Capacity in kg	-	50	70	100	100	-

LEGS COVERING FORK



FRAME MATERIAL	CUSTOMISABLE STEEL *			CUSTOMISABLE STAINLESS STEEL *		
Reference	WPR-T-9022			WPR-T-9022-SS		
Length in mm	400-800			400-800		
Width in mm	400-800			400-800		
Weight in kg	-			-		
COMPATIBLE	WP 55	WP 65	WP 85	WP 125	WP 205	WP 285
Capacity in kg	-	40	60	100	100	-

FORK FOR ROLLING TRAY FOR EU STD BINS



FRAME MATERIAL	CUSTOMISABLE STEEL *			CUSTOMISABLE STAINLESS STEEL *		
Reference	WPR-T-9023			WPR-T-9023-SS		
Length in mm	400-800			400-800		
Width in mm	400-800			400-800		
Weight in kg	-			-		
COMPATIBLE	WP 55	WP 65	WP 85	WP 125	WP 205	WP 285
Capacity in kg	-	50	70	110	150	-

FORK ACCESSORIES

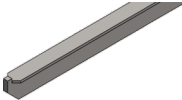
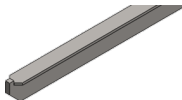
REFERENCE	DESCRIPTION	TOOLS COMPATIBILITY
 WPR-A-0020	End stops on forks	Fork Ref : WPR-T-9016
 WPR-A-0020-SS	End stops on forks - SS	Fork Ref : WPR-T-9016-SS

GRIPPER

ARTICULATED CORE GRIPPER FOR WRAPPING REEL



FRAME MATERIAL	STEEL					
Reference	WPR-T-0025					
Length in mm	-					
Width in mm	-					
Weight in kg	10					
COMPATIBLE	WP 55	WP 65	WP 85	WP 125	WP 205	WP 285
Capacity in kg	45	50	-	-	-	-

MANUAL FRONT TILTING GRIPPER FOR DRUMS



FRAME MATERIAL	CUSTOMISABLE STEEL *			CUSTOMISABLE STAINLESS STEEL *		
Reference	WPR-T-9026			WPR-T-9026-SS		
Length in mm	-			-		
Width in mm	-			-		
Weight in kg	-			-		
COMPATIBLE	WP 55	WP 65	WP 85	WP 125	WP 205	WP 285
Capacity in kg	-	-	80	80	80	-

RANGE OF TOOLS

GRIPPERS

MANUAL CORE GRIPPER WITH TILTING 90° - 80KG



FRAME MATERIAL	STAINLESS STEEL					
Reference	WPR-T-0028-SS					
Length in mm	283					
Width in mm	76					
Weight in kg	15					
COMPATIBLE	WP 55	WP 65	WP 85	WP 125	WP 205	WP 285
Capacity in kg	40	50	70	80	80	-

MANUAL CORE GRIPPER WITH TILTING 90° - 80 KG - EXTENDED



FRAME MATERIAL	STAINLESS STEEL					
Reference	WPR-T-0034-SS					
Length in mm	283					
Width in mm	76					
Weight in kg	16					
COMPATIBLE	WP 55	WP 65	WP 85	WP 125	WP 205	WP 285
Capacity in kg	40	50	70	80	80	-

VERTICAL CORE GRIPPER - 80 KG



FRAME MATERIAL	STAINLESS STEEL					
Reference	WPR-T-0029-SS					
Length in mm	283					
Width in mm	76					
Weight in kg	6					
COMPATIBLE	WP 55	WP 65	WP 85	WP 125	WP 205	WP 285
Capacity in kg	50	60	80	80	-	-

ELECTRIC CORE GRIPPER WITH TILTING 90° - 110KG



FRAME MATERIAL	STAINLESS STEEL					
Reference	WPR-T-0030-SS					
Length in mm	283					
Width in mm	76					
Weight in kg	30					
COMPATIBLE	WP 55	WP 65	WP 85	WP 125	WP 205	WP 285
Capacity in kg	-	-	-	50	110	-

ELECTRIC CORE GRIPPER WITH TILTING 90° - 200KG



FRAME MATERIAL	STEEL					
Reference	WPR-T-0037					
Length in mm	357					
Width in mm	76					
Weight in kg	52					
COMPATIBLE	WP 55	WP 65	WP 85	WP 125	WP 205	WP 285
Capacity in kg	-	-	-	-	-	200

ELECTRIC CLAMP - 100 KG



FRAME MATERIAL	STAINLESS STEEL					
Reference	WPR-T-0031-SS					
Length in mm	-					
Width in mm	-					
Weight in kg	12					
COMPATIBLE	WP 55	WP 65	WP 85	WP 125	WP 205	WP 285
Capacity in kg	-	-	-	80	100	-

ELECTRIC CLAMP WITH ROTATION SYSTEM - 100 KG









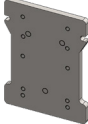

FRAME MATERIAL	STAINLESS STEEL					
Reference	WPR-T-0032-SS					
Length in mm	-					
Width in mm	-					
Weight in kg	32					
COMPATIBLE	WP 55	WP 65	WP 85	WP 125	WP 205	WP 285
Capacity in kg	-	-	-	50	100	-

RANGE OF TOOLS

GRIPPER ACCESSORIES			
	REFERENCE	DESCRIPTION	TOOLS COMPATIBILITY
	WPR-A-0017-SS	Extension for expandable hub \varnothing 76 mm - SS Capacity: 80 kg Length: 150 mm	Manual Core Gripper Ref: WPR-T-0028-SS Electric Core Gripper Ref: WPR-T-0030-SS
	WPR-A-0018-SS	Core gripper adapter for reel with core \varnothing 152 mm Capacity: 80 kg Length: 283 mm	Manual Core Gripper Ref: WPR-T-0028-SS Electric Core Gripper Ref: WPR-T-0030-SS
	WPR-A-0021-SS	Short clamping jaws with 2 rollers Height: 240 mm For load minimum diameter : 250-600 mm Jaws material to be defined: TRICOCLAIR® AL or blue silicon Price indicated for 1 piece	Electric Clamp (with or without rotation) Ref: WPR-T-0031-SS / WPR-T-0032-SS
	WPR-A-0022-SS	Long clamping jaws with 2 rollers Height: 240 mm For load minimum diameter : 250-600 mm Jaws material to be defined: TRICOCLAIR® AL or blue silicon Price indicated for 1 piece	Electric Clamp (with or without rotation) Ref: WPR-T-0031-SS / WPR-T-0032-SS
	WPR-A-0023-SS	Articulated clamping jaws with 4 rollers Height: 315 mm For load minimum diameter : 250-600 mm Price indicated for 1 piece	Electric Clamp (with or without rotation) Ref: WPR-T-0031-SS / WPR-T-0032-SS
	WPR-A-9024-SS	Jaws with adapted form to bespoke diameter Diameter to be confirmed Material of jaws to be defined: Remaline rubber or Picots rubber black Price indicated for 1 piece	Electric Clamp (with or without rotation) Ref: WPR-T-0031-SS / WPR-T-0032-SS

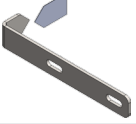
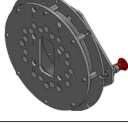
GENERAL ACCESSORIES TOOLS

	REFERENCE	DESCRIPTION	TOOLS COMPATIBILITY
	WPR-A-0001-SS	Quick change tooling light - trolley part Capacity: 125 kg Compatibility: WP 55 / WP 65 / WP 85 / WP 125 Material: Stainless steel 304 L	Only manual tools
	WPR-A-0002-SS	Quick change tooling light - tool part Capacity: 125 kg Compatibility: WP 55 / WP 65 / 85 / 125 Material: Stainless steel 304 L	Only manual tools
	WPR-A-0003-SS	Quick change tooling heavy - trolley part Capacity: 205 kg Compatibility: WP 125 / WP 205 Material: Stainless steel 304 L	Only manual tools
	WPR-A-0004-SS	Quick change tooling heavy - tool part Capacity: 205 kg Compatibility: WP 125 / WP 205 Material: Stainless steel 304 L	Only manual tools
	WPR-A-9005	Tool attachment elevation Capacity: 130 kg Height: 150-500 mm Compatibility: WP 85 / WP 125 / WP 205 Material: Steel painted RAL 7024	Only manual tools
	WPR-A-9005-SS	Tool attachment elevation - SS Capacity: 130 kg Height: 150-500 mm Compatibility: WP 85 / WP 125 / WP 205 Material: Stainless steel 304 L	Only manual tools
	WPR-A-0006	Lateral translator Capacity: 100 kg Width: 520 mm +/- 200 mm of translation on each side Capacity: 100 kg Compatibility: WP 65 / WP 85 / WP 125 / WP 205 Material: Steel painted Red RAL 7024	Only manual tools
	WPR-A-0008	Height position marking Provided with 6 position marks to be place on the mast	All tools
	WPR-A-0026-SS	Manual rotation system - 100 kg - SS Accessory weight : 6kg	Only manual custom tools for the standard version
	WPR-A-0027-SS	Electric rotation system - SS Capacity: 150 kg 360° rotation with 3 configurable position	Electric clamping WPR-T-0031-SS & manual custom tools for the standard version

RANGE OF TROLLEYS



Our range is composed of 6 different standard models from 55 kg to 285 kg capacity. Each model in our range is available in steel IP 44 and stainless steel IP 65.

STEEL RANGE



WP 55

WP 65

WP 85

WP 125

WP 205

WP 285

STAINLESS STEEL RANGE



TECHNICAL DETAILS



Size of mast

Our trolleys range comes in 4 mast heights described below. The mast heights available vary according to the model required.

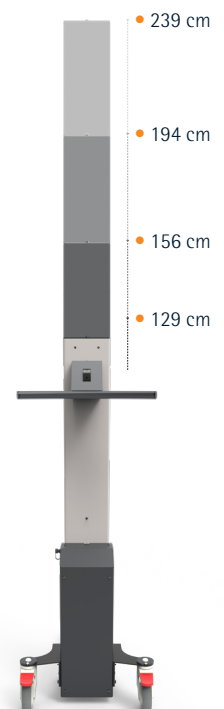

Version of Masts

Type	XS	S	M	L
Description	Very Small	Small	Medium	Large
Overall height	1290 mm	1560 mm	1940 mm	2390 mm
Elevation stroke	965 mm	1220 mm	1600 mm	2050 mm



Type of legs

Each model in our range is also available in 3 different legs type.

Version of legs			
Type	ST	AN	CEN
Description	Standard	Angle	Central
Legs lenght	420 / 500 / 650 / 850	420	420 / 500
Legs width	Front wheel - 418 Rear wheel - 538	Front wheel - 376 Rear wheel - 398	Front wheel - 174 Rear wheel - 398
Picture			

Lenght of legs

All 3 legs type comes with a length of 500 mm.
The standard version is also available with a length of 650 mm and 850 mm.

Lenghts				
Type	420	500	650	850
Compatibility	WP 55 - WP 65	From WP 85 till WP 285		WP 285

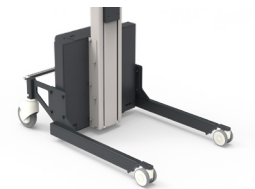

Type of front wheel

Different version of front wheels, swivel or fixed are available depending of the trolley model and application.



Version of front wheels			
Type	75	75F	80
Description	Front swivel wheel Ø 75 mm	Front fixed wheel Ø 75 mm	Front fixed wheel Ø 80 mm
Picture			



WP 125 M

➤ Type of rear wheel

Different versions of rear wheels, with individual brake or central, are available depending on the trolley model and application.

VERSION OF REAR WHEELS				
	125	125 CB	150 CB	160
Description	Ø 125 mm with brake	Ø 125 mm with central brake 3 positions	Ø 150 mm with central brake 3 positions	Ø 160 mm with brake
Picture				

➤ Control of the trolley

Our trolley range comes with a large choice of control and remotes adapted for each application. Stop button and battery level indicator on the remote control.

REMOTE CONTROLS				
Type	WPR-R55	WPR-R0	WPR-R1	
Description	Control handle WPR-R55	ErgoControl WPR-R0	ErgoControl WPR-R1	
Action	Up and down with button	Up and down with button	Up and down with remote	
Picture				
Type	WPR-R2	WPR-R3	WPR-R4	
Description	ErgoControl WPR-R2	ErgoControl WPR-R3	ErgoControl WPR-R4	
Action	Up and down & automatic level with remote	Up and down & tilting & clamping with remote	Up and down & clamping & rotation with remote	
Picture				
Type	WPR-R5	WPR-R6	WPR-R7	
Description	ErgoControl WPR-R5	ErgoControl WPR-R6	ErgoControl WPR-R7	
Action	Up and down & rotation with remote	Up and down & clamping with remote	Up and down & tilting with remote	
Picture				

WORK POSITIONER WP ONE

DESCRIPTION



The most compact and flexible lifting trolley

Our lifting trolley has been thoughtfully designed to be compact and manoeuvrable. Its slim profile ensures it won't obstruct customer flow or clutter the workspace.

Despite its small size, this trolley possesses a remarkable lifting capacity of up to 60 kg. Say goodbye to straining your back or relying on multiple trips to transport your supplies or merchandises. This trolley is engineered to handle the heavy lifting, empowering you to complete your tasks efficiently.

Whether you work in a retail shop, bookstore, workshop, or any other environment that requires frequent lifting and transportation, our trolley is the ideal tool for the job. It can effortlessly handle a variety of items, including boxes, books, supplies, and more.



1 Model



Capacity: 60 kg



Size: 1550 mm

The motor speed is 110 mm/s.

TECHNICAL SPECIFICATIONS

DESCRIPTION	WP ONE
Reference	WPR-ONE-01
Max capacity (kg)	60
Weight (kg)	31
Lifting stroke	1200
Total height	1550
Belt operating capacity (kg)	417
Belt breaking load (kg)	1615
Command type	Standard up and down button
Battery type	1 Lithium 24 V - 10 Ah
Total battery weight (kg)	2
Charger	External -100-240 V - 50-60Hz
Number of cycles	250 cycles
Battery indicator	On the handle control unit
Recharge time	7,50h for 100%
Type of legs	Angle
Front wheel	Single Ø 63 - swivel
Rear wheel	Ø 125 - with individual brake

POSSIBLE OPTION	REFERENCE
Option: Interchangeable lithium battery	Ref: WPR-O-0046
Option: Additional battery charging station	Ref: WPR-O-0047

Battery



Replaceable lithium battery with independent charging station.

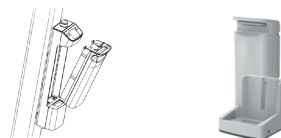

Package



Packaged & delivered in carton box, pallet of 8 units.



Fixing material, tools and accessories included.



Complete mounting instructions.

Load diagram

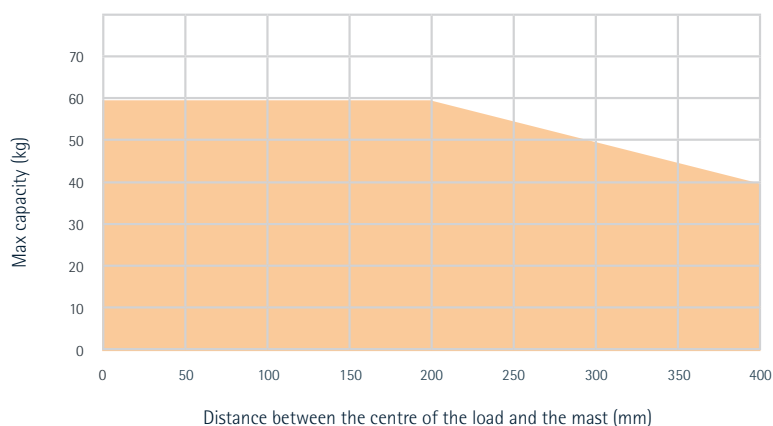

WORK POSITIONER WP 55

DESCRIPTION



An excellent partner for your back and your health

Our lifting trolley, WP 55 is a mobile solution that can be used in various environments such as food processing, industrial workshops, offices, pharmacies, libraries, or grocery stores. A solution adapted for all types of loads such as boxes, paper reels, beverage crates and other goods up to 55 kg.

This lifting trolley is a great choice for handling any lightweight or heavier objects such as crates and boxes, reels, that need to be transported from one place to another, stored or removed from shelves.

Easy to use and equipped with a wide range of tools, it will be adapted to your needs and allow you to effortlessly carry loads up to 55 kg and up to a height of 194 cm.



The model WP 55 has a total capacity of **55 kg**, at a distance of 400 mm from the mast.

The WP 55 is delivered with **AGM batteries** (24 V ; 9 Ah) as standard.

The motor speed is **120 mm/s**.

TECHNICAL SPECIFICATIONS

DESCRIPTION	WP 55
Max capacity (kg)	55
Belt operating capacity (kg)	417
Belt breaking load (kg)	1615
Command type	Standard up and down button
Battery type	2 AGM (Tot : 24 V - 9 Ah)
Total battery weight (kg)	4,85
Charger	External - 230 V - 50-60Hz
Number of cycles	150-250 cycles
Battery indicator	On the handle control unit
Recharge time	7,50h for 100%
Front wheel	Simple Ø 75 - swivel
Rear wheel	Ø 125 - with individual brake

REFERENCE	TROLLEY	LENGTH OF LEGS	WIDTH OF LEGS	TOTAL HEIGHT	LIFTING STROKE	WEIGHT
WPR-55-1110	WP 55XS-S	430	476	1290	965	33
WPR-55-1210	WP 55XS-C	422	144	1290	965	31
WPR-55-1310	WP 55XS-A	400	380	1290	965	30
WPR-55-2110	WP 55S-S	430	476	1530	1200	35
WPR-55-2210	WP 55S-C	422	144	1530	1200	33
WPR-55-2310	WP 55S-A	400	380	1530	1200	32
WPR-55-3110	WP 55M-S	430	476	1940	1600	37
WPR-55-3210	WP 55M-C	422	144	1940	1600	35
WPR-55-3310	WP 55M-A	400	380	1940	1600	34

➤ LOAD DIAGRAM

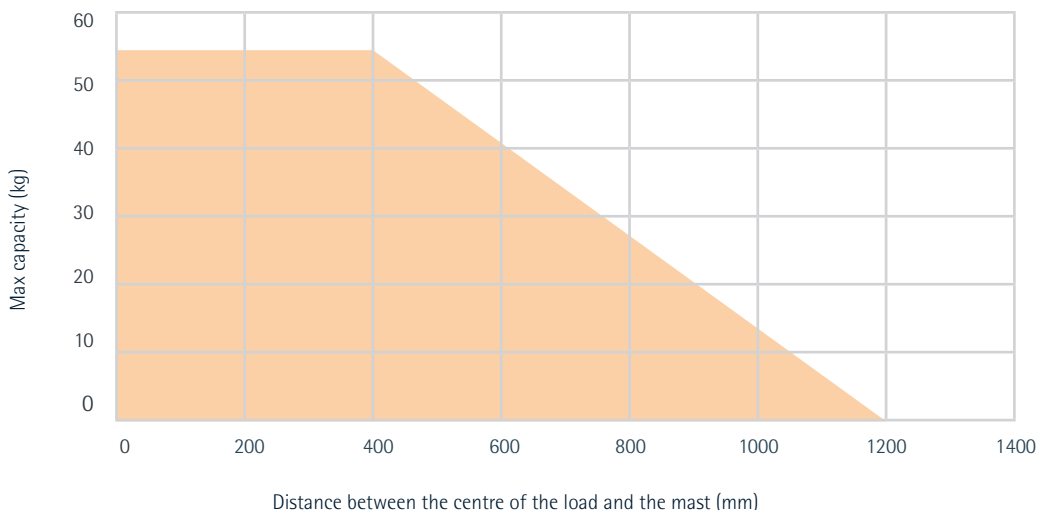

WORK POSITIONER WP 55

ORDERING INFORMATION

REMOTE CONTROL	REFERENCE
Handle with 1 button for WP 55 with progressive start	WPR-R55
OPTIONS	REFERENCE
Replacement of 2 AGM batteries by 2 lithium batteries	WPR-O-0004
Charger storage case	WPR-O-0011
Mast height custom fit (between smallest & highest mast)*	WPR-O-0019
Central brake for WP 55/65	WPR-O-0020
Conductive option on WP55 to WP125 with ESD rear wheel Ø125 - individual brake	WPR-O-0027
Conductive option on WP55 to WP125 with ESD rear wheel Ø125- central brake	WPR-O-0028
Integration of 1 replaceable battery pack up to 2 cells + charging station	WPR-O-0039
Additional AGM battery pack - 2 cells lead acid	WPR-O-0041
Additional lithium battery pack - 2 lithium cells	WPR-O-0043
Charging station for replaceable battery pack	WPR-O-0045
TOOLS	REFERENCE
Boom with wheel + V-Support 360°	WPR-T-0001
Boom with wheel + V-Support 360° - SS	WPR-T-0001-SS
Boom with wheel for V-support	WPR-T-0002
Boom with wheel for V-support - Customizable	WPR-T-9002
Boom with wheel for V-support - SS	WPR-T-0002-SS
Boom with wheel for V-support - Customizable - SS	WPR-T-9002-SS
V-Support	WPR-T-0003
V-Support - Customizable	WPR-T-9003
V-Support - SS	WPR-T-0003-SS
V-Support - Customizable - SS	WPR-T-9003-SS
Boom - tube Ø 60 - Length 500 mm	WPR-T-0004
Boom tube Ø 60 - Customizable	WPR-T-9004
Boom - tube Ø 60 - Length 500 mm - SS	WPR-T-0004-SS
Boom tube Ø 60 - Customizable - SS	WPR-T-9004-SS
Boom - tube Ø 35 - Customizable	WPR-T-9005
Boom - tube Ø 35 - Customizable - SS	WPR-T-9005-SS
Double boom - tube Ø 35 - Length 500 mm	WPR-T-0006
Double boom - tube Ø 35 - Customizable	WPR-T-9006
Double boom tube Ø 35 - Length 500 mm - SS	WPR-T-0006-SS
Double boom - tube Ø 35 - Customizable - SS	WPR-T-9006-SS
Platform stainless steel - steel frame - 500 x 500 mm - 60 kg	WPR-T-0007
Platform stainless steel - stainless steel frame - 500 x 500 mm - 60 kg	WPR-T-0007-SS
Platform stainless steel - steel frame - 500 x 500 mm - 85 kg	WPR-T-0008
Platform stainless steel - steel frame - Customizable - 85 kg	WPR-T-9008
Platform stainless steel - stainless steel frame - 500 x 500 mm - 85 kg	WPR-T-0008-SS
Platform stainless steel - stainless steel frame - Customizable - 85 kg	WPR-T-9008-SS
Platform HDPE - steel frame - 500 x 500 mm - 60 kg	WPR-T-0010
Platform HDPE - stainless steel frame - 500 x 500 mm - 60 kg	WPR-T-0010-SS
Platform HDPE - steel frame - 500 x 500 mm - 85 kg	WPR-T-0011
Platform HDPE - steel frame - Customizable - 85 kg	WPR-T-9011
Platform HDPE - stainless steel frame - 500 x 500 mm - 85 kg	WPR-T-0011-SS
Platform HDPE - stainless steel frame - Customizable - 85 kg	WPR-T-9011-SS
Platform HDPE with rolls - 500 x 500 mm - steel frame - 85 kg	WPR-T-0012
Platform HDPE with rolls - 500 x 500 mm - stainless steel frame - 80 kg	WPR-T-0012-SS
Crane arm with adjustable hook support - 200 kg	WPR-T-0015

TOOLS	REFERENCE
Crane arm with adjustable hook support - 180 kg - Customizable	WPR-T-9015
Crane arm with adjustable hook support - 200 kg - SS	WPR-T-0015-SS
Crane arm with adjustable hook support - 180 kg - Customizable - SS	WPR-T-9015-SS
Fork - 160kg - Customizable	WPR-T-9016
Fork - 160kg - Customizable - SS	WPR-T-9016-SS
Adjustable fork - length 610 mm - 85 kg	WPR-T-0018
Adjustable fork - length 610 mm - 85 kg - SS	WPR-T-0018-SS
Articulated Core Gripper for wrapping reel - 50 kg	WPR-T-0025
Manual core gripper with tilting 90° for reel - core Ø 76 mm - 80 kg - SS	WPR-T-0028-SS
Extended manual core gripper with tilting 90° for reel - core Ø 76 mm - 80 kg - SS	WPR-T-0034-SS
Vertical core gripper for reel core Ø 76 mm - 80kg - SS	WPR-T-0029-SS

ACCESSORIES	REFERENCE
Quick change tooling - trolley part - 125 kg - SS	WPR-A-0001-SS
Quick Change tooling - Tool Part - 125 kg - SS	WPR-A-0002-SS
Weighting system on crane - 200 kg	WPR-A-0007-SS
Height position marking	WPR-A-0008
Snap Hook Ø 6 - SS	WPR-A-0009-SS
Snap Hook Ø 8 - SS	WPR-A-0010-SS
Lifting chain - 1 m - SS	WPR-A-0011-SS
Safety shackle	WPR-A-0012
Safety shackle - SS	WPR-A-0012-SS
Latch hook	WPR-A-0013
Latch hook - SS	WPR-A-0013-SS
360° Latch hook	WPR-A-0014
Platform rollers Ø 50 mm with 2 fixation pieces SS	WPR-A-0015-SS
Platform edges - SS	WPR-A-0016-SS
Adjustable Crane Crossbar 60 x 40 - 600 mm	WPR-A-0019
Adjustable Crane Crossbar 60 x 40 - Customizable	WPR-A-9019
Adjustable Crane Crossbar - 600 mm - SS	WPR-A-0019-SS
Adjustable crane crossbar - Customizable - SS	WPR-A-9019-SS
End stops on forks	WPR-A-0020
End stops on forks - SS	WPR-A-0020-SS
Plate with indexing pin for 90° locking of the V platform.	WPR-A-0028-SS
Ball-screw indexing plate for 90° locking of V-platform.	WPR-A-0029-SS

WORK POSITIONER WP 55 SS

DESCRIPTION

Stainless Steel



A mini lifting trolley in stainless steel ideal for the food-industry

Our WP 55 stainless steel lifting trolley is a mobile solution adapted to many production environments subject to strict hygiene requirements, the agrifood, pharmaceutical and chemical industries. It adapts to all types of loads up to 55 kg.

Its stainless-steel structure, plastic remote control and antistatic/Conductive wheels, make this trolley your ally in demanding environments.

Easy to use and equipped with a wide range of tools, adapted to your needs, it can effortlessly carry loads up to 55 kg and up to a height of 194 cm. With these tools it becomes simple to empty bins, or to transport cans.

The model WP 55 SS has a total capacity of **55 kg**, at a distance of 400 mm from the mast.

The WP 55 SS is delivered with **AGM batteries** (24 V ; 9 Ah) as standard.

The motor speed is **120 mm/s**.

TECHNICAL SPECIFICATIONS

DESCRIPTION	WP 55 SS
Max capacity (kg)	55
Belt operating capacity (kg)	417
Belt breaking load (kg)	1615
Command type	Standard up and down button
Battery type	2 AGM (Tot : 24 V - 9 Ah)
Total battery weight (kg)	4,85
Charger	External - 230 V - 50-60Hz
Number of cycles	150-250 cycles
Battery indicator	On the handle control unit
Recharge time	7,50h for 100%
Front wheel	Simple Ø 75 - swivel
Rear wheel	Ø 125 - with individual brake

REFERENCE	TROLLEY	LENGTH OF LEGS	WIDTH OF LEGS	TOTAL HEIGHT	LIFTING STROKE	WEIGHT
WPR-55-1110-SS	WP 55XS-SS-S	430	476	1290	965	44
WPR-55-1210-SS	WP 55XS-SS-C	422	144	1290	965	42
WPR-55-1310-SS	WP 55XS-SS-A	400	380	1290	965	41
WPR-55-2110-SS	WP 55S-SS-S	430	476	1530	1200	46
WPR-55-2210-SS	WP 55S-SS-C	422	144	1530	1200	44
WPR-55-2310-SS	WP 55S-SS-A	400	380	1530	1200	43
WPR-55-3110-SS	WP 55M-SS-S	430	476	1940	1600	48
WPR-55-3210-SS	WP 55M-SS-C	422	144	1940	1600	46
WPR-55-3310-SS	WP 55M-SS-A	400	380	1940	1600	45

LOAD DIAGRAM

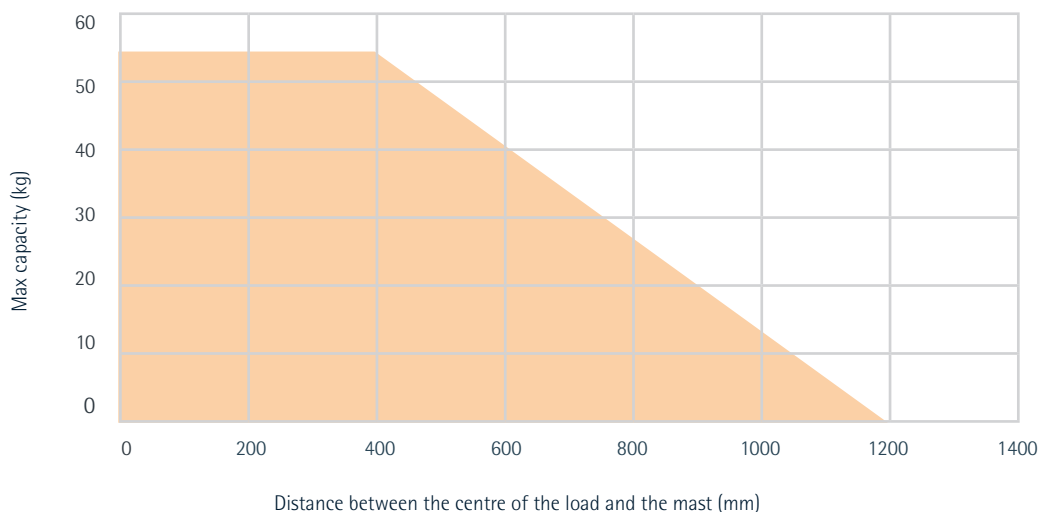

WORK POSITIONER WP 55 SS

ORDERING INFORMATION

REMOTE CONTROL	REFERENCE
Handle with 1 button for WP 55 with progressive start	WPR-R55

OPTIONS	REFERENCE
Replacement of 2 AGM batteries by 2 lithium batteries	WPR-O-0004
Charger storage case - SS	WPR-O-0011-SS
Mast height custom fit (between smallest & highest mast)*	WPR-O-0019
Central brake for WP 55 / WP 65 - SS	WPR-O-0020-SS
Conductive option on WP55 to WPI25 with ESD rear wheel Ø125 - individual brake	WPR-O-0027
Conductive option on WP55 to WPI25 with ESD rear wheel Ø125 - central brake	WPR-O-0028
Integration of 1 replaceable battery pack up to 2 cells + charging station	WPR-O-0039
Additional AGM battery pack - 2 cells lead acid	WPR-O-0041
Additional lithium battery pack - 2 lithium cells	WPR-O-0043
Charging station for replaceable battery pack	WPR-O-0045

TOOLS	REFERENCE
Boom with wheel + V-Support 360°	WPR-T-0001
Boom with wheel + V-Support 360° - SS	WPR-T-0001-SS
Boom with wheel for V-support	WPR-T-0002
Boom with wheel for V-support - Customizable	WPR-T-9002
Boom with wheel for V-support - SS	WPR-T-0002-SS
Boom with wheel for V-support - Customizable - SS	WPR-T-9002-SS
V-Support	WPR-T-0003
V-Support - Customizable	WPR-T-9003
V-Support - SS	WPR-T-0003-SS
V-Support - Customizable - SS	WPR-T-9003-SS
Boom - tube Ø 60 - Length 500 mm	WPR-T-0004
Boom tube Ø 60 - Customizable	WPR-T-9004
Boom - tube Ø 60 - Length 500 mm - SS	WPR-T-0004-SS
Boom tube Ø 60 - Customizable - SS	WPR-T-9004-SS
Boom - tube Ø 35 - Customizable	WPR-T-9005
Boom - tube Ø 35 - Customizable - SS	WPR-T-9005-SS
Double boom - tube Ø 35 - Length 500 mm	WPR-T-0006
Double boom - tube Ø 35 - Customizable	WPR-T-9006
Double boom tube Ø 35 - Length 500 mm - SS	WPR-T-0006-SS
Double boom - tube Ø 35 - Customizable - SS	WPR-T-9006-SS
Platform stainless steel - steel frame - 500 x 500 mm - 60 kg	WPR-T-0007
Platform stainless steel - stainless steel frame - 500 x 500 mm - 60 kg	WPR-T-0007-SS
Platform stainless steel - steel frame - 500 x 500 mm - 85 kg	WPR-T-0008
Platform stainless steel - steel frame - Customizable - 85 kg	WPR-T-9008
Platform stainless steel - stainless steel frame - 500 x 500 mm - 85 kg	WPR-T-0008-SS
Platform stainless steel - stainless steel frame - Customizable - 85 kg	WPR-T-9008-SS
Platform HDPE - steel frame - 500 x 500 mm - 60 kg	WPR-T-0010
Platform HDPE - stainless steel frame - 500 x 500 mm - 60 kg	WPR-T-0010-SS
Platform HDPE - steel frame - 500 x 500 mm - 85 kg	WPR-T-0011
Platform HDPE - steel frame - Customizable - 85 kg	WPR-T-9011
Platform HDPE - stainless steel frame - 500 x 500 mm - 85 kg	WPR-T-0011-SS
Platform HDPE - stainless steel frame - Customizable - 85 kg	WPR-T-9011-SS
Platform HDPE with rolls - 500 x 500 mm - steel frame - 85 kg	WPR-T-0012
Platform HDPE with rolls - 500 x 500 mm - stainless steel frame - 80 kg	WPR-T-0012-SS
Crane arm with adjustable hook support - 200 kg	WPR-T-0015
Crane arm with adjustable hook support - 180 kg - Customizable	WPR-T-9015

TOOLS	REFERENCE
Crane arm with adjustable hook support - 200 kg - SS	WPR-T-0015-SS
Crane arm with adjustable hook support - 180 kg - Customizable - SS	WPR-T-9015-SS
Fork - 160kg - Customizable	WPR-T-9016
Fork - 160kg - Customizable - SS	WPR-T-9016-SS
Adjustable fork - length 610 mm - 85 kg	WPR-T-0018
Adjustable fork - length 610 mm - 85 kg - SS	WPR-T-0018-SS
Articulated Core Gripper for wrapping reel - 50 kg	WPR-T-0025
Manual core gripper with tilting 90° for reel - core Ø 76 mm - 80 kg - SS	WPR-T-0028-SS
Extended manual core gripper with tilting 90° for reel - core Ø 76 mm - 80 kg - SS	WPR-T-0034-SS
Vertical core gripper for reel core Ø 76 mm - 80kg - SS	WPR-T-0029-SS

ACCESSORIES	REFERENCE
Quick change tooling - trolley part - 125 kg - SS	WPR-A-0001-SS
Quick Change tooling - Tool Part - 125 kg - SS	WPR-A-0002-SS
Weighting system on crane - 200 kg	WPR-A-0007-SS
Height position marking	WPR-A-0008
Snap Hook Ø 6 - SS	WPR-A-0009-SS
Snap Hook Ø 8 - SS	WPR-A-0010-SS
Lifting chain - 1 m - SS	WPR-A-0011-SS
Safety shackle	WPR-A-0012
Safety shackle - SS	WPR-A-0012-SS
Latch hook	WPR-A-0013
Latch hook - SS	WPR-A-0013-SS
360° Latch hook	WPR-A-0014
Platform rollers Ø 50 mm with 2 fixation pieces SS	WPR-A-0015-SS
Platform edges - SS	WPR-A-0016-SS
Adjustable Crane Crossbar 60 x 40 - 600 mm	WPR-A-0019
Adjustable Crane Crossbar 60 x 40 - Customizable	WPR-A-9019
Adjustable Crane Crossbar - 600 mm - SS	WPR-A-0019-SS
Adjustable crane crossbar - Customizable - SS	WPR-A-9019-SS
End stops on forks	WPR-A-0020
End stops on forks - SS	WPR-A-0020-SS
Plate with indexing pin for 90° locking of the V platform.	WPR-A-0028-SS
Ball-screw indexing plate for 90° locking of V-platform.	WPR-A-0029-SS

WORK POSITIONER WP 65

DESCRIPTION



For light and easy handling

Easy to use, our WP 65 Steel Lifting trolley is equipped with an electric lifting system. The different compatible remotes adapt to the tool and your specific needs; lift, clamp or tilt.

The trolley has been designed for easy maintenance and repairs.

Compact and robust, its aluminium and steel structure makes it light and resistant. It can lift 65 kg of load up to a height of 194 cm.

It is suitable for handling various loads such as cartons, reels and crates.

Its overload limiter guarantees optimal safety, and has great manoeuvrability thanks to its movable front wheels.

The model WP 65 has a total capacity of **65 kg**, at a distance of 400 mm from the mast.

The WP 65 is delivered with **AGM batteries** (24 V ; 9 Ah) as standard.

The motor speed is **120 mm/s**.

TECHNICAL SPECIFICATIONS

DESCRIPTION	WP 65
Max capacity (kg)	65
Belt operating capacity (kg)	417
Belt breaking load (kg)	1615
Command type	Remote control
Battery type	2 AGM (Tot : 24 V - 9 Ah)
Total battery weight (kg)	4,85
Charger	External - 230 V - 50-60Hz
Number of cycles	150-250 cycles
Battery indicator	On the remote control unit
Recharge time	7,50h for 100%
Front wheel	Simple Ø 75 - swivel
Rear wheel	Ø 125 - with individual brake

REFERENCE	TROLLEY	LENGTH OF LEGS	WIDTH OF LEGS	TOTAL HEIGHT	LIFTING STROKE	WEIGHT
WPR-65-1110	WP 65XS-S	430	476	1290	965	37
WPR-65-1210	WP 65XS-C	422	144	1290	965	31
WPR-65-1310	WP 65XS-A	400	380	1290	965	34
WPR-65-2110	WP 65S-S	430	476	1530	1200	39
WPR-65-2210	WP 65S-C	422	144	1530	1200	33
WPR-65-2310	WP 65S-A	400	380	1530	1200	36
WPR-65-3110	WP 65M-S	430	476	1940	1600	41
WPR-65-3210	WP 65M-C	422	144	1940	1600	35
WPR-65-3310	WP 65M-A	400	380	1940	1600	38

▶ LOAD DIAGRAM

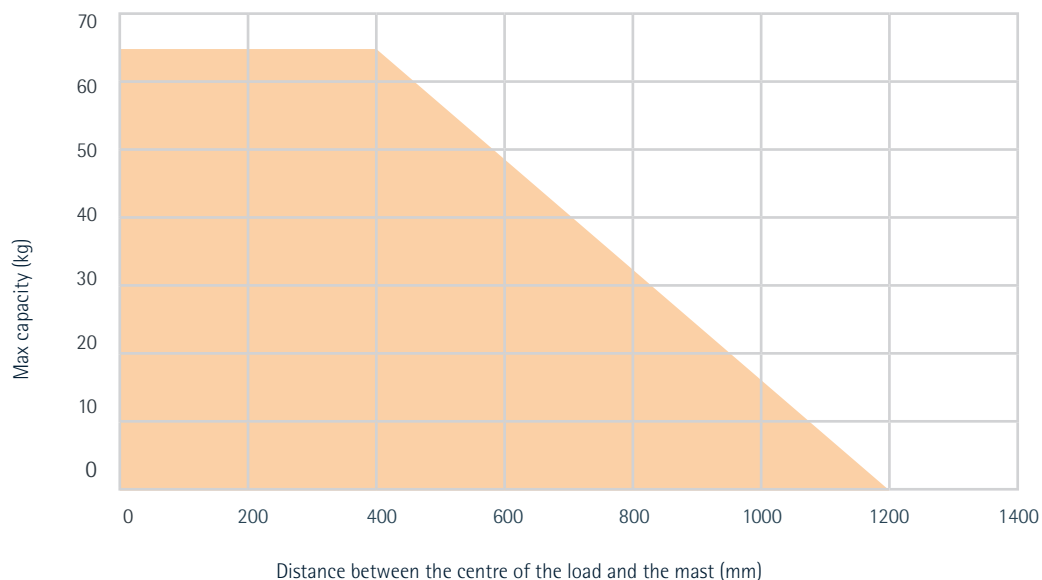

WORK POSITIONER WP 65

ORDERING INFORMATION

REMOTE CONTROL	REFERENCE
ERGOCONTROL handle with 1 button	WPR-RO
ERGOCONTROL handle Remote with function up and down	WPR-R1
ERGOCONTROL handle Remote with function up and down + option automatic level / positioner	WPR-R2

OPTIONS	REFERENCE
Automatic level option with unit cell in a casing	WPR-O-0001
Positioner system with multiple position	WPR-O-0002
Replacement of 2 AGM batteries by 2 lithium batteries	WPR-O-0004
Charger storage case	WPR-O-0011
Width reduction of the legs between standard and central legs width	WPR-O-0016
Mast height custom fit (between smallest & highest mast)*	WPR-O-0019
Central brake for WP 55/65	WPR-O-0020
Fixed front wheel Ø 75 mm - for legs ST/CEN - WP 65	WPR-O-0022
Conductive option on WP55 to WPI25 with ESD rear wheel Ø125 - individual brake	WPR-O-0027
Conductive option on WP55 to WPI25 with ESD rear wheel Ø125- central brake	WPR-O-0028
Integration of 1 replaceable battery pack up to 2 cells + charging station	WPR-O-0039
Additional AGM battery pack - 2 cells lead acid	WPR-O-0041
Additional lithium battery pack - 2 lithium cells	WPR-O-0043
Charging station for replaceable battery pack	WPR-O-0045

TOOLS	REFERENCE
Boom with wheel + V-Support 360°	WPR-T-0001
Boom with wheel + V-Support 360° - SS	WPR-T-0001-SS
Boom with wheel for V-support	WPR-T-0002
Boom with wheel for V-support - Customizable	WPR-T-9002
Boom with wheel for V-support - SS	WPR-T-0002-SS
Boom with wheel for V-support - Customizable - SS	WPR-T-9002-SS
V-Support	WPR-T-0003
V-Support - Customizable	WPR-T-9003
V-Support - SS	WPR-T-0003-SS
V-Support - Customizable - SS	WPR-T-9003-SS
Boom - tube Ø 60 - Length 500 mm	WPR-T-0004
Boom tube Ø 60 - Customizable	WPR-T-9004
Boom - tube Ø 60 - Length 500 mm - SS	WPR-T-0004-SS
Boom tube Ø 60 - Customizable - SS	WPR-T-9004-SS
Boom - tube Ø 35 - Customizable	WPR-T-9005
Boom - tube Ø 35 - Customizable - SS	WPR-T-9005-SS
Double boom - tube Ø 35 - Length 500 mm	WPR-T-0006
Double boom - tube Ø 35 - Customizable	WPR-T-9006
Double boom tube Ø 35 - Length 500 mm - SS	WPR-T-0006-SS
Double boom - tube Ø 35 - Customizable - SS	WPR-T-9006-SS
Platform stainless steel - steel frame - 500 x 500 mm - 60 kg	WPR-T-0007
Platform stainless steel - stainless steel frame - 500 x 500 mm - 60 kg	WPR-T-0007-SS
Platform stainless steel - steel frame - 500 x 500 mm - 85 kg	WPR-T-0008
Platform stainless steel - steel frame - Customizable - 85 kg	WPR-T-9008
Platform stainless steel - stainless steel frame - 500 x 500 mm - 85 kg	WPR-T-0008-SS
Platform stainless steel - stainless steel frame - Customizable - 85 kg	WPR-T-9008-SS
Platform HDPE - steel frame - 500 x 500 mm - 60 kg	WPR-T-0010
Platform HDPE - stainless steel frame - 500 x 500 mm - 60 kg	WPR-T-0010-SS
Platform HDPE - steel frame - 500 x 500 mm - 85 kg	WPR-T-0011
Platform HDPE - steel frame - Customizable - 85 kg	WPR-T-9011

TOOLS	REFERENCE
Platform HDPE - stainless steel frame - 500 x 500 mm - 85 kg	WPR-T-0011-SS
Platform HDPE - stainless steel frame - Customizable - 85 kg	WPR-T-9011-SS
Platform HDPE with rolls - 500 x 500 mm - steel frame - 85 kg	WPR-T-0012
Platform HDPE with rolls - 500 x 500 mm - stainless steel frame - 80 kg	WPR-T-0012-SS
Wave Platform - 80 kg	WPR-T-0014
Wave Platform - 80 kg - SS	WPR-T-0014-SS
Crane arm with adjustable hook support - 200 kg	WPR-T-0015
Crane arm with adjustable hook support - 180 kg - Customizable	WPR-T-9015
Crane arm with adjustable hook support - 200 kg - SS	WPR-T-0015-SS
Crane arm with adjustable hook support - 180 kg - Customizable - SS	WPR-T-9015-SS
Fork - 160kg - Customizable	WPR-T-9016
Fork - 160kg - Customizable - SS	WPR-T-9016-SS
Adjustable fork - length 610 mm - 85 kg	WPR-T-0018
Adjustable fork - length 610 mm - 85 kg - SS	WPR-T-0018-SS
Symmetric adjustable fork - 180 kg - Customizable	WPR-T-9019
Symmetric adjustable fork - 180 kg - Customizable - SS	WPR-T-9019-SS
Symmetric adjustable fork - 180 kg - Customizable - SS	WPR-T-9019-SS
4-cleat fork - 100 kg - Customizable	WPR-T-9020-SS
8-cleat fork - 140 kg - Customizable	WPR-T-9021-SS
Legs Covering fork - 100 kg	WPR-T-9022
Legs Covering fork - 100 kg - SS	WPR-T-9022-SS
Fork for gripping rolling tray for EU std Bins -150 kg	WPR-T-9023
Fork for gripping rolling tray for EU std Bins - 150 kg - SS	WPR-T-9023-SS
Articulated Core Gripper for wrapping reel - 50 kg	WPR-T-0025
Manual core gripper with tilting 90° for reel - core Ø 76 mm - 80 kg - SS	WPR-T-0028-SS
Extended manual core gripper with tilting 90° for reel - core Ø 76 mm - 80 kg - SS	WPR-T-0034-SS
Vertical core gripper for reel core Ø 76 mm - 80kg - SS	WPR-T-0029-SS

ACCESSORIES	REFERENCE
Quick change tooling - trolley part - 125 kg - SS	WPR-A-0001-SS
Quick Change tooling - Tool Part - 125 kg - SS	WPR-A-0002-SS
Lateral translator ± 200 mm	WPR-A-0006
Weighting system on crane - 200 kg	WPR-A-0007-SS
Height position marking	WPR-A-0008
Snap Hook Ø 6 - SS	WPR-A-0009-SS
Snap Hook Ø 8 - SS	WPR-A-0010-SS
Lifting chain - 1 m - SS	WPR-A-0011-SS
Safety shackle	WPR-A-0012
Safety shackle - SS	WPR-A-0012-SS
Latch hook	WPR-A-0013
Latch hook - SS	WPR-A-0013-SS
360° Latch hook	WPR-A-0014
Platform rollers Ø 50 mm with 2 fixation pieces SS	WPR-A-0015-SS
Platform edges - SS	WPR-A-0016-SS
Adjustable Crane Crossbar 60 x 40 - 600 mm	WPR-A-0019
Adjustable Crane Crossbar 60 x 40 - Customizable	WPR-A-9019
Adjustable Crane Crossbar - 600 mm - SS	WPR-A-0019-SS
Adjustable crane crossbar - Customizable - SS	WPR-A-9019-SS
End stops on forks	WPR-A-0020
End stops on forks - SS	WPR-A-0020-SS
Short clamping jaws with 2 rollers*	WPR-A-0021-SS
Electric rotation System - 120 kg - SS*	WPR-A-0027-SS
Plate with indexing pin for 90° locking of the V platform.	WPR-A-0028-SS

WORK POSITIONER WP 65 SS

DESCRIPTION

Stainless Steel



Ergonomic handling for the food and pharmaceutical industries

Our WP 65 SS in Stainless Steel lifting trolley is a lightweight and elegant lifting device that is suitable for demanding production environments, subject to strict hygiene rules, such as the food, pharmaceutical and chemical industries.

The overall structure is made of stainless steel (electropolished), the remote control for lifting and lowering is plastic IP66. This trolley lifts, moves and handles loads weighing up to 65 kg and up to a height of 194 cm.

It pairs with many stainless steel tools, resistant to cleaning and hygiene rules.

This Work Positioner relieves you of any type of operation and improves working conditions, while improving productivity.

The model WP 65 SS has a total capacity of **65 kg**, at a distance of 400 mm from the mast.

The WP 65 SS is delivered with **AGM batteries** (24 V ; 9 Ah) as standard.

The motor speed is **120 mm/s**.

TECHNICAL SPECIFICATIONS

DESCRIPTION	WP 65 SS
Max capacity (kg)	65
Belt operating capacity (kg)	417
Belt breaking load (kg)	1615
Command type	Remote control
Battery type	2 AGM (Tot : 24 V - 9 Ah)
Total battery weight (kg)	4,85
Charger	External - 230 V - 50-60Hz
Number of cycles	150-250 cycles
Battery indicator	On the remote control unit
Recharge time	7,50h for 100%
Front wheel	Simple Ø 75 - swivel
Rear wheel	Ø 125 - with individual brake

REFERENCE	TROLLEY	LENGTH OF LEGS	WIDTH OF LEGS	TOTAL HEIGHT	LIFTING STROKE	WEIGHT
WPR-65-1110-SS	WP 65XS-SS-S	430	476	1290	965	46
WPR-65-1210-SS	WP 65XS-SS-C	422	144	1290	965	41
WPR-65-1310-SS	WP 65XS-SS-A	400	380	1290	965	45
WPR-65-2110-SS	WP 65S-SS-S	430	476	1530	1200	48
WPR-65-2210-SS	WP 65S-SS-C	422	144	1530	1200	43
WPR-65-2310-SS	WP 65S-SS-A	400	380	1530	1200	45
WPR-65-3110-SS	WP 65M-SS-S	430	476	1940	1600	50
WPR-65-3210-SS	WP 65M-SS-C	422	144	1940	1600	45
WPR-65-3310-SS	WP 65M-SS-A	400	380	1940	1600	47

▶ LOAD DIAGRAM

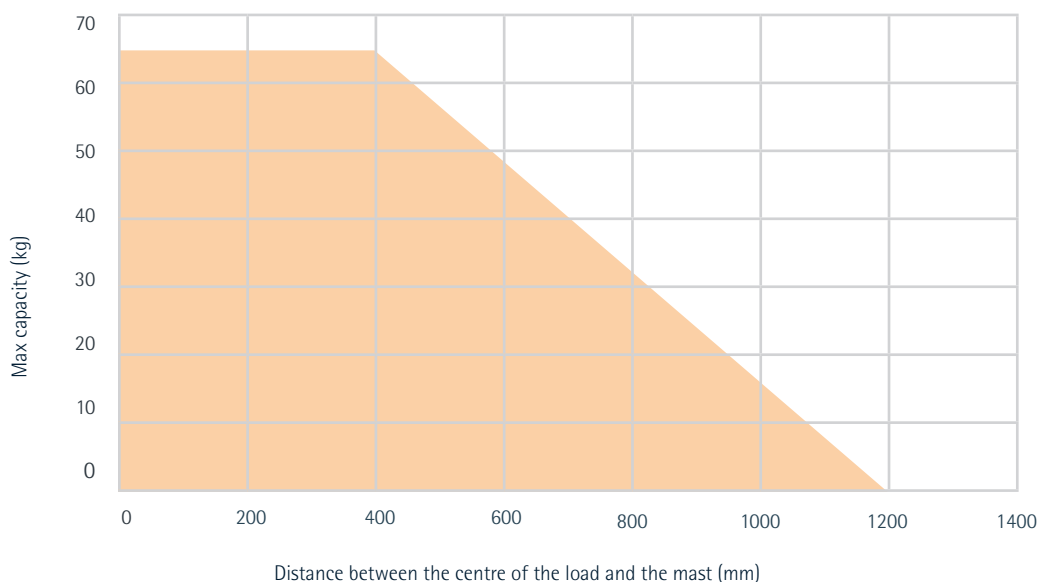

WORK POSITIONER WP 65 SS

ORDERING INFORMATION

REMOTE CONTROL	REFERENCE
ERGOCONTROL handle in stainless steel with 1 button	WPR-RO-SS
ERGOCONTROL handle Remote with function up and down	WPR-RI
ERGOCONTROL handle Remote with function up and down + option automatic level / positioner	WPR-R2

OPTIONS	REFERENCE
Automatic level option with unit cell in a casing	WPR-O-0001
Positioner system with multiple position	WPR-O-0002
Replacement of 2 AGM batteries by 2 lithium batteries	WPR-O-0004
Charger storage case - SS	WPR-O-0011-SS
Width reduction of the legs between standard and central legs width	WPR-O-0016
Mast height custom fit (between smallest & highest mast)*	WPR-O-0019
Central brake for WP 55 / WP 65 - SS	WPR-O-0020-SS
Fixed front wheel Ø 75 mm - for legs ST/CEN - WP 65 - SS	WPR-O-0022-SS
Conductive option on WP55 to WPI25 with ESD rear wheel Ø125 - individual brake	WPR-O-0027
Conductive option on WP55 to WPI25 with ESD rear wheel Ø125 - central brake	WPR-O-0028
Integration of 1 replaceable battery pack up to 2 cells + charging station	WPR-O-0039
Additional AGM battery pack - 2 cells lead acid	WPR-O-0041
Additional lithium battery pack - 2 lithium cells	WPR-O-0043
Charging station for replaceable battery pack	WPR-O-0045

TOOLS	REFERENCE
Boom with wheel + V-Support 360°	WPR-T-0001
Boom with wheel + V-Support 360° - SS	WPR-T-0001-SS
Boom with wheel for V-support	WPR-T-0002
Boom with wheel for V-support - Customizable	WPR-T-9002
Boom with wheel for V-support - SS	WPR-T-0002-SS
Boom with wheel for V-support - Customizable - SS	WPR-T-9002-SS
V-Support	WPR-T-0003
V-Support - Customizable	WPR-T-9003
V-Support - SS	WPR-T-0003-SS
V-Support - Customizable - SS	WPR-T-9003-SS
Boom - tube Ø 60 - Length 500 mm	WPR-T-0004
Boom tube Ø 60 - Customizable	WPR-T-9004
Boom - tube Ø 60 - Length 500 mm - SS	WPR-T-0004-SS
Boom tube Ø 60 - Customizable - SS	WPR-T-9004-SS
Boom - tube Ø 35 - Customizable	WPR-T-9005
Boom - tube Ø 35 - Customizable - SS	WPR-T-9005-SS
Double boom - tube Ø 35 - Length 500 mm	WPR-T-0006
Double boom - tube Ø 35 - Customizable	WPR-T-9006
Double boom tube Ø 35 - Length 500 mm - SS	WPR-T-0006-SS
Double boom - tube Ø 35 - Customizable - SS	WPR-T-9006-SS
Platform stainless steel - steel frame - 500 x 500 mm - 60 kg	WPR-T-0007
Platform stainless steel - stainless steel frame - 500 x 500 mm - 60 kg	WPR-T-0007-SS
Platform stainless steel - steel frame - 500 x 500 mm - 85 kg	WPR-T-0008
Platform stainless steel - steel frame - Customizable - 85 kg	WPR-T-9008
Platform stainless steel - stainless steel frame - 500 x 500 mm - 85 kg	WPR-T-0008-SS
Platform stainless steel - stainless steel frame - Customizable - 85 kg	WPR-T-9008-SS
Platform HDPE - steel frame - 500 x 500 mm - 60 kg	WPR-T-0010
Platform HDPE - stainless steel frame - 500 x 500 mm - 60 kg	WPR-T-0010-SS
Platform HDPE - steel frame - 500 x 500 mm - 85 kg	WPR-T-0011
Platform HDPE - steel frame - Customizable - 85 kg	WPR-T-9011
Platform HDPE - stainless steel frame - 500 x 500 mm - 85 kg	WPR-T-0011-SS

TOOLS	REFERENCE
Platform HDPE - stainless steel frame - Customizable - 85 kg	WPR-T-9011-SS
Platform HDPE with rolls - 500 x 500 mm - steel frame - 85 kg	WPR-T-0012
Platform HDPE with rolls - 500 x 500 mm - stainless steel frame - 80 kg	WPR-T-0012-SS
Wave Platform - 80 kg	WPR-T-0014
Wave Platform - 80 kg - SS	WPR-T-0014-SS
Crane arm with adjustable hook support - 200 kg	WPR-T-0015
Crane arm with adjustable hook support - 180 kg - Customizable	WPR-T-9015
Crane arm with adjustable hook support - 200 kg - SS	WPR-T-0015-SS
Crane arm with adjustable hook support - 180 kg - Customizable - SS	WPR-T-9015-SS
Fork - 160kg - Customizable	WPR-T-9016
Fork - 160kg - Customizable - SS	WPR-T-9016-SS
Adjustable fork - length 610 mm - 85 kg	WPR-T-0018
Adjustable fork - length 610 mm - 85 kg - SS	WPR-T-0018-SS
Symmetric adjustable fork - 180 kg - Customizable	WPR-T-9019
Symmetric adjustable fork - 180 kg - Customizable - SS	WPR-T-9019-SS
4-cleat fork - 100 kg - Customizable	WPR-T-9020-SS
8-cleat fork - 140 kg - Customizable	WPR-T-9021-SS
8-cleat fork with adjustable width - 100 kg - Customizable	WPR-T-9038-SS
Legs Covering fork - 100 kg	WPR-T-9022
Legs Covering fork - 100 kg - SS	WPR-T-9022-SS
Fork for gripping rolling tray for EU std Bins -150 kg	WPR-T-9023
Fork for gripping rolling tray for EU std Bins - 150 kg - SS	WPR-T-9023-SS
Articulated Core Gripper for wrapping reel - 50 kg	WPR-T-0025
Manual core gripper with tilting 90° for reel - core Ø 76 mm - 80 kg - SS	WPR-T-0028-SS
Extended manual core gripper with tilting 90° for reel - core Ø 76 mm - 80 kg - SS	WPR-T-0034-SS
Vertical core gripper for reel core Ø 76 mm - 80kg - SS	WPR-T-0029-SS

ACCESSORIES	REFERENCE
Quick change tooling - trolley part - 125 kg - SS	WPR-A-0001-SS
Quick Change tooling - Tool Part - 125 kg - SS	WPR-A-0002-SS
Quick change tooling - trolley part - 205 kg - SS	WPR-A-0003-SS
Quick change tooling - tool part - 205 kg - SS	WPR-A-0004-SS
Tool attachment elevation - 150-500 mm	WPR-A-9005
Tool attachment elevation - 150-500 mm - SS	WPR-A-9005-SS
Lateral translator ± 200 mm	WPR-A-0006
Weighting system on crane - 200 kg	WPR-A-0007-SS
Height position marking	WPR-A-0008
Snap Hook Ø 6 - SS	WPR-A-0009-SS
Snap Hook Ø 8 - SS	WPR-A-0010-SS
Lifting chain - 1 m - SS	WPR-A-0011-SS
Safety shackle	WPR-A-0012
Safety shackle - SS	WPR-A-0012-SS
Latch hook	WPR-A-0013
Latch hook - SS	WPR-A-0013-SS
360° Latch hook	WPR-A-0014
Platform rollers Ø 50 mm with 2 fixation pieces SS	WPR-A-0015-SS
Platform edges - SS	WPR-A-0016-SS
Extension for expandable hub Ø 76 mm - SS	WPR-A-0017-SS
Core gripper adapter for reel with core Ø 150 mm	WPR-A-0018-SS
Adjustable Crane Crossbar 60 x 40 - 600 mm	WPR-A-0019
Adjustable Crane Crossbar 60 x 40 - Customizable	WPR-A-9019
Adjustable Crane Crossbar - 600 mm - SS	WPR-A-0019-SS

WORK POSITIONER WP 85

DESCRIPTION



For light and easy handling

Our WP 85 lift trolley is a reliable AGM battery lifter, moving, transferring, gripping loads such as coils, boxes, cartons, or other loads up to a weight of 85 kg.

Silent, and very manoeuvrable, it has 3 mast heights and can be combined with bases of different lengths and different wheels.

In addition, it is equipped with a charger and a battery indicator.

Many tools can easily fit on the WP 85 trolley, which offers great flexibility in your daily work and real relief for your operators.



The model WP 85 has a total capacity of **85 kg**, at a distance of 400 mm from the mast.

The WP 85 is delivered with **AGM batteries** (24 V ; 9 Ah) as standard.

The motor speed is **120 mm/s**.

TECHNICAL SPECIFICATIONS

DESCRIPTION	WP 85
Max capacity (kg)	85
Belt operating capacity (kg)	417
Belt breaking load (kg)	1615
Command type	Remote control
Battery type	2 AGM (Tot : 24 V - 9 Ah)
Total battery weight (kg)	4,85
Charger	External - 230 V - 50-60Hz
Number of cycles	100-200 cycles
Battery indicator	On the remote control unit
Recharge time	7,50h for 100%
Front wheel	Simple Ø 50 - swivel
Rear wheel	Ø 125 - with individual brake

REFERENCE	TROLLEY	LENGTH OF LEGS	WIDTH OF LEGS	TOTAL HEIGHT	LIFTING STROKE	WEIGHT
WPR-85-2120	WP 85S-S-500	505	486	1560	1220	45
WPR-85-2130	WP 85S-S-650	656	486	1560	1220	46
WPR-85-2220	WP 85S-C-500	505	146	1560	1220	45
WPR-85-3120	WP 85M-S-500	505	486	1940	1600	48
WPR-85-3130	WP 85M-S-650	656	486	1940	1600	49
WPR-85-3220	WP 85M-C-500	505	146	1940	1600	48
WPR-85-4120	WP 85L-S-500	505	486	2390	2050	60
WPR-85-4130	WP 85L-S-650	656	486	2390	2050	61

▶ LOAD DIAGRAM

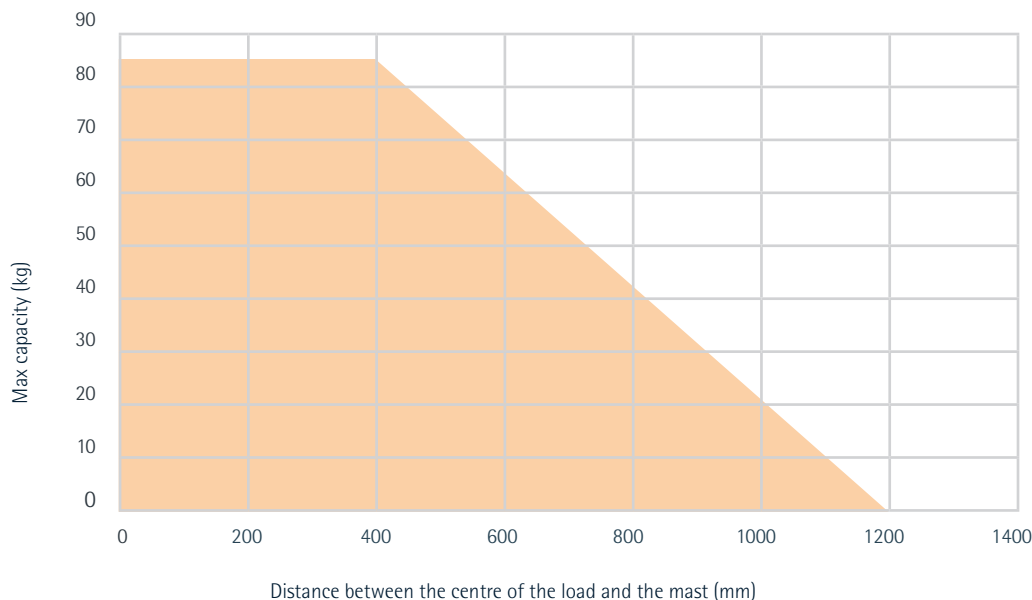

WORK POSITIONER WP 85

ORDERING INFORMATION

REMOTE CONTROL	REFERENCE
ERGOCONTROL handle with 1 button	WPR-RO
ERGOCONTROL handle Remote with function up and down	WPR-RI
ERGOCONTROL handle Remote with function up and down + option automatic level / positioner	WPR-R2

OPTIONS	REFERENCE
Automatic level option with unit cell in a casing	WPR-O-0001
Positioner system with multiple position	WPR-O-0002
Replacement of 2 AGM batteries by 2 lithium batteries	WPR-O-0004
Lateral rollers for tool holder carriage*	WPR-O-0010-SS
Charger storage case	WPR-O-0011
Legs enlargement up to 650 mm - WP 85	WPR-O-0012
Width reduction of the legs between standard and central legs width	WPR-O-0016
Mast height custom fit (between smallest & highest mast)*	WPR-O-0019
Central brake for WP 85	WPR-O-0021
Fixed front wheel Ø 75 mm - for legs ST 500 - WP 85	WPR-O-0023
Fixed front wheel Ø 75 mm - for legs ST 650 - WP 85	WPR-O-0024
Conductive option on WP55 to WPI25 with ESD rear wheel Ø125 - individual brake	WPR-O-0027
Conductive option on WP55 to WPI25 with ESD rear wheel Ø125- central brake	WPR-O-0028
Counterweight 25 kg - WP 85	WPR-O-0032
Counterweight 5 kg - WP 85	WPR-O-0033
Integration of 1 replaceable battery pack up to 2 cells + charging station	WPR-O-0039
Additional AGM battery pack - 2 cells lead acid	WPR-O-0041
Additional lithium battery pack - 2 lithium cells	WPR-O-0043
Charging station for replaceable battery pack	WPR-O-0045

TOOLS	REFERENCE
Boom with wheel + V-Support 360°	WPR-T-0001
Boom with wheel + V-Support 360° - SS	WPR-T-0001-SS
Boom with wheel for V-support	WPR-T-0002
Boom with wheel for V-support - Customizable	WPR-T-9002
Boom with wheel for V-support - SS	WPR-T-0002-SS
Boom with wheel for V-support - Customizable - SS	WPR-T-9002-SS
V-Support	WPR-T-0003
V-Support - Customizable	WPR-T-9003
V-Support - SS	WPR-T-0003-SS
V-Support - Customizable - SS	WPR-T-9003-SS
Boom - tube Ø 60 - Length 500 mm	WPR-T-0004
Boom tube Ø 60 - Customizable	WPR-T-9004
Boom - tube Ø 60 - Length 500 mm - SS	WPR-T-0004-SS
Boom tube Ø 60 - Customizable - SS	WPR-T-9004-SS
Boom - tube Ø 35 - Customizable	WPR-T-9005
Boom - tube Ø 35 - Customizable - SS	WPR-T-9005-SS
Double boom - tube Ø 35 - Length 500 mm	WPR-T-0006
Double boom - tube Ø 35 - Customizable	WPR-T-9006
Double boom tube Ø 35 - Length 500 mm - SS	WPR-T-0006-SS
Double boom - tube Ø 35 - Customizable - SS	WPR-T-9006-SS
Platform stainless steel - steel frame - 500 x 500 mm - 60 kg	WPR-T-0007
Platform stainless steel - stainless steel frame - 500 x 500 mm - 60 kg	WPR-T-0007-SS
Platform stainless steel - steel frame - 500 x 500 mm - 85 kg	WPR-T-0008
Platform stainless steel - steel frame - Customizable - 85 kg	WPR-T-9008
Platform stainless steel - stainless steel frame - 500 x 500 mm - 85 kg	WPR-T-0008-SS

TOOLS	REFERENCE
Platform stainless steel - stainless steel frame - Customizable - 85 kg	WPR-T-9008-SS
Platform HDPE - steel frame - 500 x 500 mm - 60 kg	WPR-T-0010
Platform HDPE - stainless steel frame - 500 x 500 mm - 60 kg	WPR-T-0010-SS
Platform HDPE - steel frame - 500 x 500 mm - 85 kg	WPR-T-0011
Platform HDPE - steel frame - Customizable - 85 kg	WPR-T-9011
Platform HDPE - stainless steel frame - 500 x 500 mm - 85 kg	WPR-T-0011-SS
Platform HDPE - stainless steel frame - Customizable - 85 kg	WPR-T-9011-SS
Platform HDPE with rolls - 500 x 500 mm - steel frame - 85 kg	WPR-T-0012
Platform HDPE with rolls - 500 x 500 mm - stainless steel frame - 80 kg	WPR-T-0012-SS
Wave Platform - 80 kg	WPR-T-0014
Wave Platform - 80 kg - SS	WPR-T-0014-SS
Crane arm with adjustable hook support - 200 kg	WPR-T-0015
Crane arm with adjustable hook support - 180 kg - Customizable	WPR-T-9015
Crane arm with adjustable hook support - 200 kg - SS	WPR-T-0015-SS
Crane arm with adjustable hook support - 180 kg - Customizable - SS	WPR-T-9015-SS
Fork - 160kg - Customizable	WPR-T-9016
Fork - 160kg - Customizable - SS	WPR-T-9016-SS
Adjustable fork - length 610 mm - 85 kg	WPR-T-0018
Adjustable fork - length 610 mm - 85 kg - SS	WPR-T-0018-SS
Symmetric adjustable fork - 180 kg - Customizable	WPR-T-9019
Symmetric adjustable fork - 180 kg - Customizable - SS	WPR-T-9019-SS
4-cleat fork - 100 kg - Customizable	WPR-T-9020-SS
8-cleat fork - 140 kg - Customizable	WPR-T-9021-SS
8-cleat fork with adjustable width - 100 kg - Customizable	WPR-T-9038-SS
Legs Covering fork - 100 kg	WPR-T-9022
Legs Covering fork - 100 kg - SS	WPR-T-9022-SS
Fork for gripping rolling tray for EU std Bins -150 kg	WPR-T-9023
Fork for gripping rolling tray for EU std Bins - 150 kg - SS	WPR-T-9023-SS
Manual front tilting gripper for drums - 80 kg	WPR-T-9026
Manual front tilting gripper for drums - 80 kg - SS	WPR-T-9026-SS
Manual core gripper with tilting 90° for reel - core Ø 76 mm - 80 kg - SS	WPR-T-0028-SS
Extended manual core gripper with tilting 90° for reel - core Ø 76 mm - 80 kg - SS	WPR-T-0034-SS
Vertical core gripper for reel core Ø 76 mm - 80kg - SS	WPR-T-0029-SS

ACCESSORIES	REFERENCE
Quick change tooling - trolley part - 125 kg - SS	WPR-A-0001-SS
Quick Change tooling - Tool Part - 125 kg - SS	WPR-A-0002-SS
Quick change tooling - trolley part - 205 kg - SS	WPR-A-0003-SS
Quick change tooling - tool part - 205 kg - SS	WPR-A-0004-SS
Tool attachment elevation - 150-500 mm	WPR-A-9005
Tool attachment elevation - 150-500 mm - SS	WPR-A-9005-SS
Lateral translator ± 200 mm	WPR-A-0006
Weighting system on crane - 200 kg	WPR-A-0007-SS
Height position marking	WPR-A-0008
Snap Hook Ø 6 - SS	WPR-A-0009-SS
Snap Hook Ø 8 - SS	WPR-A-0010-SS
Lifting chain - 1 m - SS	WPR-A-0011-SS
Safety shackle	WPR-A-0012
Safety shackle - SS	WPR-A-0012-SS
Latch hook	WPR-A-0013

WORK POSITIONER WP 85

ORDERING INFORMATION

ACCESSORIES	REFERENCE
Latch hook - SS	WPR-A-0013-SS
360° Latch hook	WPR-A-0014
Platform rollers Ø 50 mm with 2 fixation pieces SS	WPR-A-0015-SS
Platform edges - SS	WPR-A-0016-SS
Extension for expandable hub Ø 76 mm - SS	WPR-A-0017-SS
Core gripper adapter for reel with core Ø 150 mm	WPR-A-0018-SS
Adjustable Crane Crossbar 60 x 40 - 600 mm	WPR-A-0019
Adjustable Crane Crossbar 60 x 40 - Customizable	WPR-A-9019
Adjustable Crane Crossbar - 600 mm - SS	WPR-A-0019-SS
Adjustable crane crossbar - Customizable - SS	WPR-A-9019-SS
End stops on forks	WPR-A-0020
End stops on forks - SS	WPR-A-0020-SS
Short clamping jaws with 2 rollers*	WPR-A-0021-SS
Long clamping jaws with 2 rollers*	WPR-A-0022-SS
Articulated clamping jaws with 4 rollers*	WPR-A-0023-SS
Jaws with adapted form to bespoke diameter*	WPR-A-9024-SS
Manual rotation system - 100 kg - SS	WPR-A-0026-SS
Electric rotation System - 150 kg - SS*	WPR-A-0027-SS
Plate with indexing pin for 90° locking of the V platform.	WPR-A-0028-SS
Ball-screw indexing plate for 90° locking of V-platform.	WPR-A-0029-SS



WORK POSITIONER WP 85 SS

DESCRIPTION

Stainless Steel



Class II

IP 65

Quick and easy to clean

Specially designed for demanding environments such as the food, pharmaceutical or chemical industries, our WP 85 stainless steel lifting trolley will adapt perfectly to the strict hygiene and cleaning requirements (IP65).

The WP 85 SS trolley, as well as our wide range of compatible tools are made of stainless steel. It easily lifts, moves and dumps loads up to 85 kg. It is equipped with a two-speed control remote control and has a built-in overload limiter, clutch and battery indicator.

The different possible combinations of wheels, legs and mast heights give it adaptability to your specific needs.



The model WP 85 SS has a total capacity of **85 kg**, at a distance of 400 mm from the mast.

The WP 85 SS is delivered with **AGM batteries** (24 V ; 9 Ah) as standard.

The motor speed is **120 mm/s**.

TECHNICAL SPECIFICATIONS

DESCRIPTION	WP 85 SS
Max capacity (kg)	85
Belt operating capacity (kg)	417
Belt breaking load (kg)	1615
Command type	Remote control
Battery type	2 AGM (Tot : 24 V - 9 Ah)
Total battery weight (kg)	4,85
Charger	External - 230 V - 50-60Hz
Number of cycles	100-200 cycles
Battery indicator	On the remote control unit
Recharge time	7,50h for 100%
Front wheel	Simple Ø 50 - swivel
Rear wheel	Ø 125 - with individual brake

REFERENCE	TROLLEY	LENGTH OF LEGS	WIDTH OF LEGS	TOTAL HEIGHT	LIFTING STROKE	WEIGHT
WPR-85-2120-SS	WP 85S-SS-S-500	505	486	1560	1220	50
WPR-85-2130-SS	WP 85S-SS-S-650	505	486	1560	1220	51
WPR-85-2220-SS	WP 85S-SS-C-500	505	146	1560	1220	50
WPR-85-3120-SS	WP 85M-SS-S-500	505	486	1940	1600	52
WPR-85-3130-SS	WP 85M-SS-S-650	656	486	1940	1600	53
WPR-85-3220-SS	WP 85M-SS-C-500	505	146	1940	1600	52
WPR-85-4120-SS	WP 85L-SS-S-500	505	486	2390	2050	54
WPR-85-4130-SS	WP 85L-SS-S-650	656	486	2390	2050	55

➤ LOAD DIAGRAM

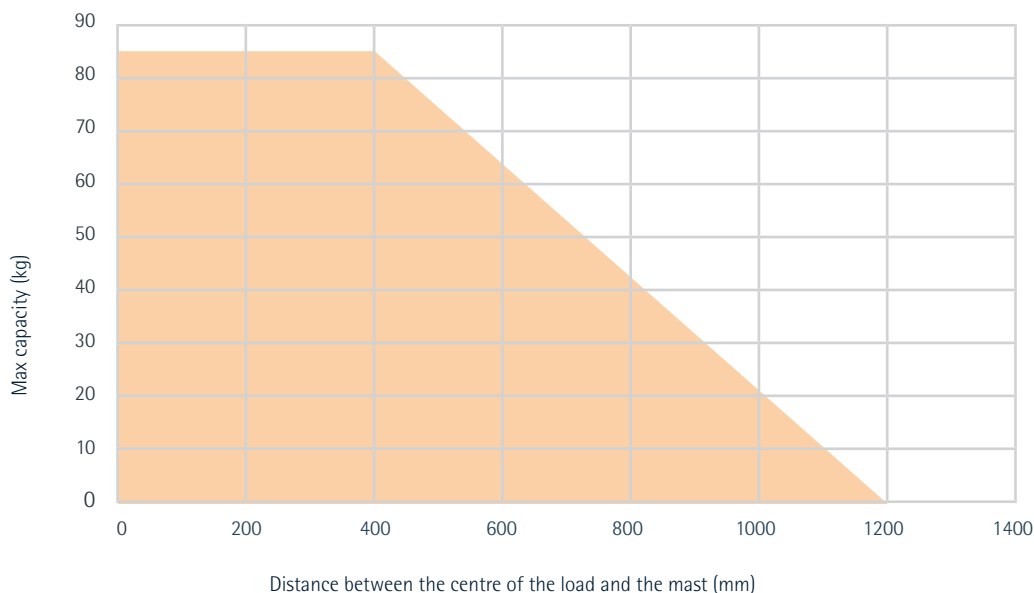

WORK POSITIONER WP 85 SS

ORDERING INFORMATION

REMOTE CONTROL	REFERENCE
ERGOCONTROL handle in stainless steel with 1 button	WPR-RO-SS
ERGOCONTROL handle Remote with function up and down	WPR-RI
ERGOCONTROL handle Remote with function up and down + option automatic level / positioner	WPR-R2

OPTIONS	REFERENCE
Automatic level option with unit cell in a casing	WPR-O-0001
Positioner system with multiple position	WPR-O-0002
Replacement of 2 AGM batteries by 2 lithium batteries	WPR-O-0004
Lateral rollers for tool holder carriage*	WPR-O-0010-SS
Charger storage case - SS	WPR-O-0011-SS
Legs enlargement up to 650 mm - WP 85 - SS	WPR-O-0012-SS
Width reduction of the legs between standard and central legs width	WPR-O-0016
Mast height custom fit (between smallest & highest mast)*	WPR-O-0019
Central brake for WP 85 - SS	WPR-O-0021-SS
Fixed front wheel Ø 75 mm - for legs ST 500 - WP 85 - SS	WPR-O-0023-SS
Fixed front wheel Ø 75 mm - for legs ST 650 - WP 85 - SS	WPR-O-0024-SS
Conductive option on WP55 to WPI25 with ESD rear wheel Ø125 - individual brake	WPR-O-0027
Conductive option on WP55 to WPI25 with ESD rear wheel Ø125- central brake	WPR-O-0028
Counterweight 25 kg - WP 85 - SS	WPR-O-0032-SS
Counterweight 5 kg - WP 85 - SS	WPR-O-0033-SS
Integration of 1 replaceable battery pack up to 2 cells + charging station	WPR-O-0039
Additional AGM battery pack - 2 cells lead acid	WPR-O-0041
Additional lithium battery pack - 2 lithium cells	WPR-O-0043
Charging station for replaceable battery pack	WPR-O-0045

TOOLS	REFERENCE
Boom with wheel + V-Support 360°	WPR-T-0001
Boom with wheel + V-Support 360° - SS	WPR-T-0001-SS
Boom with wheel for V-support	WPR-T-0002
Boom with wheel for V-support - Customizable	WPR-T-9002
Boom with wheel for V-support - SS	WPR-T-0002-SS
Boom with wheel for V-support - Customizable - SS	WPR-T-9002-SS
V-Support	WPR-T-0003
V-Support - Customizable	WPR-T-9003
V-Support - SS	WPR-T-0003-SS
V-Support - Customizable - SS	WPR-T-9003-SS
Boom - tube Ø 60 - Length 500 mm	WPR-T-0004
Boom tube Ø 60 - Customizable	WPR-T-9004
Boom - tube Ø 60 - Length 500 mm - SS	WPR-T-0004-SS
Boom tube Ø 60 - Customizable - SS	WPR-T-9004-SS
Boom - tube Ø 35 - Customizable	WPR-T-9005
Boom - tube Ø 35 - Customizable - SS	WPR-T-9005-SS
Double boom - tube Ø 35 - Length 500 mm	WPR-T-0006
Double boom - tube Ø 35 - Customizable	WPR-T-9006
Double boom tube Ø 35 - Length 500 mm - SS	WPR-T-0006-SS
Double boom - tube Ø 35 - Customizable - SS	WPR-T-9006-SS
Platform stainless steel - steel frame - 500 x 500 mm - 60 kg	WPR-T-0007
Platform stainless steel - stainless steel frame - 500 x 500 mm - 60 kg	WPR-T-0007-SS
Platform stainless steel - steel frame - 500 x 500 mm - 85 kg	WPR-T-0008
Platform stainless steel - steel frame - Customizable - 85 kg	WPR-T-9008
Platform stainless steel - stainless steel frame - 500 x 500 mm - 85 kg	WPR-T-0008-SS

TOOLS	REFERENCE
Platform stainless steel - stainless steel frame - Customizable - 85 kg	WPR-T-9008-SS
Platform HDPE - steel frame - 500 x 500 mm - 60 kg	WPR-T-0010
Platform HDPE - stainless steel frame - 500 x 500 mm - 60 kg	WPR-T-0010-SS
Platform HDPE - steel frame - 500 x 500 mm - 85 kg	WPR-T-0011
Platform HDPE - steel frame - Customizable - 85 kg	WPR-T-9011
Platform HDPE - stainless steel frame - 500 x 500 mm - 85 kg	WPR-T-0011-SS
Platform HDPE - stainless steel frame - Customizable - 85 kg	WPR-T-9011-SS
Platform HDPE with rolls - 500 x 500 mm - steel frame - 85 kg	WPR-T-0012
Platform HDPE with rolls - 500 x 500 mm - stainless steel frame - 80 kg	WPR-T-0012-SS
Wave Platform - 80 kg	WPR-T-0014
Wave Platform - 80 kg - SS	WPR-T-0014-SS
Crane arm with adjustable hook support - 200 kg	WPR-T-0015
Crane arm with adjustable hook support - 180 kg - Customizable	WPR-T-9015
Crane arm with adjustable hook support - 200 kg - SS	WPR-T-0015-SS
Crane arm with adjustable hook support - 180 kg - Customizable - SS	WPR-T-9015-SS
Fork - 160kg - Customizable	WPR-T-9016
Fork - 160kg - Customizable - SS	WPR-T-9016-SS
Adjustable fork - length 610 mm - 85 kg	WPR-T-0018
Adjustable fork - length 610 mm - 85 kg - SS	WPR-T-0018-SS
Symmetric adjustable fork - 180 kg - Customizable	WPR-T-9019
Symmetric adjustable fork - 180 kg - Customizable - SS	WPR-T-9019-SS
4-cleat fork - 100 kg - Customizable	WPR-T-9020-SS
8-cleat fork - 140 kg - Customizable	WPR-T-9021-SS
8-cleat fork with adjustable width - 100 kg - Customizable	WPR-T-9038-SS
Legs Covering fork - 100 kg	WPR-T-9022
Legs Covering fork - 100 kg - SS	WPR-T-9022-SS
Fork for gripping rolling tray for EU std Bins -150 kg	WPR-T-9023
Fork for gripping rolling tray for EU std Bins - 150 kg - SS	WPR-T-9023-SS
Manual front tilting gripper for drums - 80 kg	WPR-T-9026
Manual front tilting gripper for drums - 80 kg - SS	WPR-T-9026-SS
Manual core gripper with tilting 90° for reel - core Ø 76 mm - 80 kg - SS	WPR-T-0028-SS
Extended manual core gripper with tilting 90° for reel - core Ø 76 mm - 80 kg - SS	WPR-T-0034-SS
Vertical core gripper for reel core Ø 76 mm - 80kg - SS	WPR-T-0029-SS

ACCESSORIES	REFERENCE
Quick change tooling - trolley part - 125 kg - SS	WPR-A-0001-SS
Quick Change tooling - Tool Part - 125 kg - SS	WPR-A-0002-SS
Quick change tooling - trolley part - 205 kg - SS	WPR-A-0003-SS
Quick change tooling - tool part - 205 kg - SS	WPR-A-0004-SS
Tool attachment elevation - 150-500 mm	WPR-A-9005
Tool attachment elevation - 150-500 mm - SS	WPR-A-9005-SS
Lateral translator ± 200 mm	WPR-A-0006
Weighting system on crane - 200 kg	WPR-A-0007-SS
Height position marking	WPR-A-0008
Snap Hook Ø 6 - SS	WPR-A-0009-SS
Snap Hook Ø 8 - SS	WPR-A-0010-SS
Lifting chain - 1 m - SS	WPR-A-0011-SS
Safety shackle	WPR-A-0012
Safety shackle - SS	WPR-A-0012-SS
Latch hook	WPR-A-0013
Latch hook - SS	WPR-A-0013-SS

WORK POSITIONER WP 85 SS

ORDERING INFORMATION

ACCESSORIES	REFERENCE
360° Latch hook	WPR-A-0014
Platform rollers Ø 50 mm with 2 fixation pieces SS	WPR-A-0015-SS
Platform edges - SS	WPR-A-0016-SS
Extension for expandable hub Ø 76 mm - SS	WPR-A-0017-SS
Core gripper adapter for reel with core Ø 150 mm	WPR-A-0018-SS
Adjustable Crane Crossbar 60 x 40 - 600 mm	WPR-A-0019
Adjustable Crane Crossbar 60 x 40 - Customizable	WPR-A-9019
Adjustable Crane Crossbar - 600 mm - SS	WPR-A-0019-SS
Adjustable crane crossbar - Customizable - SS	WPR-A-9019-SS
End stops on forks	WPR-A-0020
End stops on forks - SS	WPR-A-0020-SS
Short clamping jaws with 2 rollers*	WPR-A-0021-SS
Long clamping jaws with 2 rollers*	WPR-A-0022-SS
Articulated clamping jaws with 4 rollers*	WPR-A-0023-SS
Jaws with adapted form to bespoke diameter*	WPR-A-9024-SS
Manual rotation system - 100 kg - SS	WPR-A-0026-SS
Electric rotation System - 120 kg - SS*	WPR-A-0027-SS
Plate with indexing pin for 90° locking of the V platform.	WPR-A-0028-SS
Ball-screw indexing plate for 90° locking of V-platform.	WPR-A-0029-SS

Ba2i

Instansi Bontolone Frangipane

LEVEL

WP 85 M

WORK POSITIONER WP 125

DESCRIPTION



Customizable with a wide choice of tools

Our WP 125 lifting trolley is suitable for small and medium-sized loads. Thanks to its compact, robust appearance and movable front wheels, it is easy to handle and can lift loads up to 125 kg.

It has overload protection, a safety clutch and soft start for easy handling.

Our wide range of standard or custom-made tools allows you to lift loads such as coils, bins, pallets or reels.

Our ergonomic lift trolley WP 125 adapts to all types of sectors, industrial production, tertiary, automotive, aeronautics and logistics. We have a solution to your problem.

The model WP 125 has a total capacity of **125 kg**, at a distance of 400 mm from the mast.

The WP 125 is delivered with **AGM batteries** (24 V ; 9 Ah) as standard.

The motor speed is **120 mm/s**.

TECHNICAL SPECIFICATIONS

Max capacity mast S & M (kg)	125
Max capacity mast L (kg)	110
Belt operating capacity (kg)	417
Belt breaking load (kg)	1615
Command type	Remote control
Battery type	2 AGM (Tot : 24 V - 9 Ah)
Total battery weight (kg)	4,85
Charger	External - 230 V - 50-60Hz
Number of cycles	80-150 cycles
Battery indicator	On the remote control unit
Recharge time	7,50h for 100%
Front wheel	Double Ø 75 - swivel
Rear wheel	Ø 125 - with central brake

REFERENCE	TROLLEY	LENGTH OF LEGS	WIDTH OF LEGS	TOTAL HEIGHT	LIFTING STROKE	WEIGHT
WPR-125-2120	WP 125S-S-500	500	530	1560	1220	58
WPR-125-2130	WP 125S-S-650	650	530	1560	1220	59
WPR-125-2220	WP 125S-C-500	500	146	1560	1220	58
WPR-125-3120	WP 125M-S-500	500	530	1940	1600	60
WPR-125-3130	WP 125M-S-650	650	530	1940	1600	61
WPR-125-3220	WP 125M-C-500	500	146	1940	1600	60
WPR-125-4120	WP 125L-S-500	500	530	2390	2050	63
WPR-125-4130	WP 125L-S-650	650	530	2390	2050	64

▶ LOAD DIAGRAM

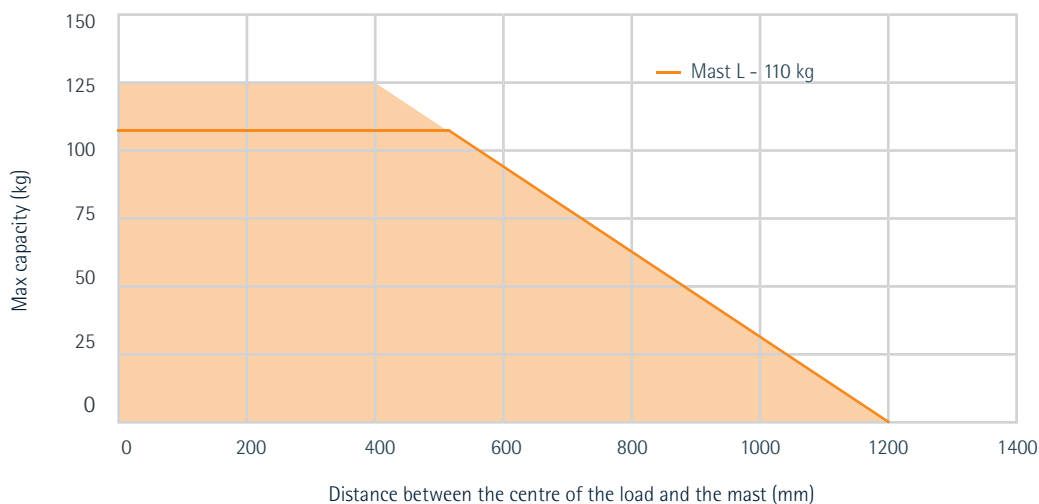

WORK POSITIONER WP 125

ORDERING INFORMATION

REFERENCE	TROLLEY
WPR-I25-2I20	WP 125S-S-500
WPR-I25-2I30	WP 125S-S-650
WPR-I25-2220	WP 125S-C-500
WPR-I25-3I20	WP 125M-S-500
WPR-I25-3I30	WP 125M-S-650
WPR-I25-3220	WP 125M-C-500
WPR-I25-4I20	WP 125L-S-500
WPR-I25-4I30	WP 125L-S-650

REMOTE CONTROL	REFERENCE
ERGOCONTROL handle with 1 button	WPR-RO
ERGOCONTROL handle Remote with function up and down	WPR-RI
ERGOCONTROL handle Remote with function up and down + option automatic level / positioner	WPR-R2
ERGOCONTROL handle Remote + clamping + tilting	WPR-R3
ERGOCONTROL handle Remote with function up and down + clamping + rotation	WPR-R4
ERGOCONTROL handle Remote with function up and down + rotation	WPR-R5
ERGOCONTROL handle Remote with function up and down + clamping	WPR-R6
ERGOCONTROL handle Remote with function up and down + tilting	WPR-R7

OPTIONS	REFERENCE
Automatic level option with unit cell in a casing	WPR-O-0001
Positioner system with multiple position	WPR-O-0002
2 additional AGM battery WP 125*	WPR-O-0003
Replacement of 2 AGM batteries by 2 lithium batteries	WPR-O-0004
2 Additional lithium battery	WPR-O-0006
1 Additional electric function*	WPR-O-0007
2 Additional electric functions*	WPR-O-0008
Lateral rollers for tool holder carriage*	WPR-O-0010-SS
Charger storage case	WPR-O-0011
Legs enlargement between 530 and 800 mm WP 125	WPR-O-0013
Width reduction of the legs between standard and central legs width	WPR-O-0016
Mast height custom fit (between smallest & highest mast)*	WPR-O-0019
Legs length custom fit between 150 and 650 mm WP 125	WPR-O-0017
Fixed front wheel Ø 75 mm - for WP 125	WPR-O-0025
Conductive option on WP55 to WPI25 with ESD rear wheel Ø125 - individual brake	WPR-O-0027
Conductive option on WP55 to WPI25 with ESD rear wheel Ø125 - central brake	WPR-O-0028
Rear wheel with individual brake for WP 125 - STD 500mm - replacement of the central brake	WPR-O-0048
Rear wheel with individual brake for WP 125 - STD 650mm - replacement of the central brake	WPR-O-0049
Rear wheel with individual brake for WP 125 - Central - replacement of the central brake	WPR-O-0050
Front swivelling wheels Ø 125 mm	WPR-O-0031
Counterweight 25 kg - WP 125	WPR-O-0034
Counterweight 5 kg - WP 125	WPR-O-0035
3 Steps ladder with rotation on mast	WPR-O-0038-SS
Integration of 1 replaceable battery pack up to 2 cells + charging station	WPR-O-0039
Additional AGM battery pack - 2 cells lead acid	WPR-O-0041
Additional lithium battery pack - 2 lithium cells	WPR-O-0043
Charging station for replaceable battery pack	WPR-O-0045

TOOLS	REFERENCE
Boom with wheel + V-Support 360°	WPR-T-0001
Boom with wheel + V-Support 360° - SS	WPR-T-0001-SS

TOOLS	REFERENCE
Boom with wheel for V-support	WPR-T-0002
Boom with wheel for V-support - Customizable	WPR-T-9002
Boom with wheel for V-support - SS	WPR-T-0002-SS
Boom with wheel for V-support - Customizable - SS	WPR-T-9002-SS
V-Support	WPR-T-0003
V-Support - Customizable	WPR-T-9003
V-Support - SS	WPR-T-0003-SS
V-Support - Customizable - SS	WPR-T-9003-SS
Boom - tube Ø 60 - Length 500 mm	WPR-T-0004
Boom tube Ø 60 - Customizable	WPR-T-9004
Boom - tube Ø 60 - Length 500 mm - SS	WPR-T-0004-SS
Boom tube Ø 60 - Customizable - SS	WPR-T-9004-SS
Boom - tube Ø 35 - Customizable	WPR-T-9005
Boom - tube Ø 35 - Customizable - SS	WPR-T-9005-SS
Double boom - tube Ø 35 - Length 500 mm	WPR-T-0006
Double boom - tube Ø 35 - Customizable	WPR-T-9006
Double boom tube Ø 35 - Length 500 mm - SS	WPR-T-0006-SS
Double boom - tube Ø 35 - Customizable - SS	WPR-T-9006-SS
Platform stainless steel - steel frame - 500 x 500 mm - 60 kg	WPR-T-0007
Platform stainless steel - stainless steel frame - 500 x 500 mm - 60 kg	WPR-T-0007-SS
Platform stainless steel - steel frame - 500 x 500 mm - 85 kg	WPR-T-0008
Platform stainless steel - steel frame - Customizable - 85 kg	WPR-T-9008
Platform stainless steel - stainless steel frame - 500 x 500 mm - 85 kg	WPR-T-0008-SS
Platform stainless steel - stainless steel frame - Customizable - 85 kg	WPR-T-9008-SS
Platform HDPE - steel frame - 500 x 500 mm - 60 kg	WPR-T-0010
Platform HDPE - stainless steel frame - 500 x 500 mm - 60 kg	WPR-T-0010-SS
Platform HDPE - steel frame - 500 x 500 mm - 85 kg	WPR-T-0011
Platform HDPE - steel frame - Customizable - 85 kg	WPR-T-9011
Platform HDPE - stainless steel frame - 500 x 500 mm - 85 kg	WPR-T-0011-SS
Platform HDPE - stainless steel frame - Customizable - 85 kg	WPR-T-9011-SS
Platform HDPE with rolls - 500 x 500 mm - steel frame - 85 kg	WPR-T-0012
Platform HDPE with rolls - 500 x 500 mm - stainless steel frame - 80 kg	WPR-T-0012-SS
Platform HDPE - steel frame - 500 x 500 mm - 200 kg	WPR-T-0013
Platform HDPE - stainless steel frame - 500 x 500 mm - 200 kg	WPR-T-0013-SS
Platform HDPE - steel frame - Customizable - 200 kg	WPR-T-9013
Platform HDPE - stainless steel frame - Customizable - 200 kg	WPR-T-9013-SS
Wave Platform - 80 kg	WPR-T-0014
Wave Platform - 80 kg - SS	WPR-T-0014-SS
Crane arm with adjustable hook support - 200 kg	WPR-T-0015
Crane arm with adjustable hook support - 180 kg - Customizable	WPR-T-9015
Crane arm with adjustable hook support - 200 kg - SS	WPR-T-0015-SS
Crane arm with adjustable hook support - 180 kg - Customizable - SS	WPR-T-9015-SS
Fork - 160kg - Customizable	WPR-T-9016
Fork - 160kg - Customizable - SS	WPR-T-9016-SS
Adjustable fork - length 610 mm - 85 kg	WPR-T-0018
Adjustable fork - length 610 mm - 85 kg - SS	WPR-T-0018-SS
Symmetric adjustable fork - 180 kg - Customizable	WPR-T-9019
Symmetric adjustable fork - 180 kg - Customizable - SS	WPR-T-9019-SS
4-cleat fork - 100 kg - Customizable	WPR-T-9020-SS

WORK POSITIONER WP 125



ORDERING INFORMATION

TOOLS	REFERENCE
8-cleat fork - 140 kg - Customizable	WPR-T-9021-SS
8-cleat fork with adjustable width - 100 kg - Customizable	WPR-T-9038-SS
Legs Covering fork - 100 kg	WPR-T-9022
Legs Covering fork - 100 kg - SS	WPR-T-9022-SS
Fork for gripping rolling tray for EU std Bins -150 kg	WPR-T-9023
Fork for gripping rolling tray for EU std Bins - 150 kg - SS	WPR-T-9023-SS
Manual front tilting gripper for drums - 80 kg	WPR-T-9026
Manual front tilting gripper for drums - 80 kg - SS	WPR-T-9026-SS
Manual core gripper with tilting 90° for reel - core Ø 76 mm - 80 kg - SS	WPR-T-0028-SS
Extended manual core gripper with tilting 90° for reel - core Ø 76 mm - 80 kg - SS	WPR-T-0034-SS
Vertical core gripper for reel core Ø 76 mm - 80kg - SS	WPR-T-0029-SS
Electric core gripper with tilting 90° for reel core Ø 76 mm - 110kg - SS*	WPR-T-0030-SS
Electric clamp - 100 kg - SS*	WPR-T-0031-SS
Electric clamp with rotation system - 100 kg - SS*	WPR-T-0032-SS
ACCESSORIES	REFERENCE
Quick change tooling - trolley part - 125 kg - SS	WPR-A-0001-SS
Quick Change tooling - Tool Part - 125 kg - SS	WPR-A-0002-SS
Quick change tooling - trolley part - 205 kg - SS	WPR-A-0003-SS
Quick change tooling - tool part - 205 kg - SS	WPR-A-0004-SS
Tool attachment elevation - 150-500 mm	WPR-A-9005
Tool attachment elevation - 150-500 mm - SS	WPR-A-9005-SS
Lateral translator ± 200 mm	WPR-A-0006
Weighting system on crane - 200 kg	WPR-A-0007-SS
Height position marking	WPR-A-0008
Snap Hook Ø 6 - SS	WPR-A-0009-SS
Snap Hook Ø 8 - SS	WPR-A-0010-SS
Lifting chain - 1 m - SS	WPR-A-0011-SS
Safety shackle	WPR-A-0012
Safety shackle - SS	WPR-A-0012-SS
Latch hook	WPR-A-0013
Latch hook - SS	WPR-A-0013-SS
360° Latch hook	WPR-A-0014
Platform rollers Ø 50 mm with 2 fixation pieces SS	WPR-A-0015-SS
Platform edges - SS	WPR-A-0016-SS
Extension for expandable hub Ø 76 mm - SS	WPR-A-0017-SS
Core gripper adapter for reel with core Ø 150 mm	WPR-A-0018-SS
Adjustable Crane Crossbar 60 x 40 - 600 mm	WPR-A-0019
Adjustable Crane Crossbar 60 x 40 - Customizable	WPR-A-9019
Adjustable Crane Crossbar - 600 mm - SS	WPR-A-0019-SS
Adjustable crane crossbar - Customizable - SS	WPR-A-9019-SS
End stops on forks	WPR-A-0020
End stops on forks - SS	WPR-A-0020-SS
Short clamping jaws with 2 rollers*	WPR-A-0021-SS
Long clamping jaws with 2 rollers*	WPR-A-0022-SS
Articulated clamping jaws with 4 rollers*	WPR-A-0023-SS
Jaws with adapted form to bespoke diameter*	WPR-A-9024-SS
Manual rotation system - 100 kg - SS	WPR-A-0026-SS
Electric rotation System - 150 kg - SS*	WPR-A-0027-SS
Plate with indexing pin for 90° locking of the V platform.	WPR-A-0028-SS
Ball-screw indexing plate for 90° locking of V-platform.	WPR-A-0029-SS



WP 125

WORK POSITIONER WP 125 SS

DESCRIPTION



Stainless Steel



Customizable with a wide choice of tools

Our WP 125 SS stainless steel is a powerful lifting trolley that lifts, moves and handles loads up to 125 kg.

Its stainless steel design gives it the right to access all demanding industrial environments, such as community kitchens, agri-food, medical and pharmaceutical. Thanks to its IP65 it withstands deep cleaning and a humid environments, as well as in cold areas.

With its 8 versions and a lifting stroke up to 205 cm it adapts to your constraints and many loads, bins, drums, coils. It comes in standard and central legs.

Thanks to its constant level option, it allows the goods to be automatically positioned at the right height, thus preventing the operator from bending down.

The model WP 125 SS has a total capacity of **125 kg**, at a distance of 400 mm from the mast.

The WP 125 SS is delivered with **AGM batteries** (24 V ; 9 Ah) as standard.

The motor speed is **120 mm/s**.

TECHNICAL SPECIFICATIONS

DESCRIPTION	WP 125 SS
Max capacity mast S & M (kg)	125
Max capacity mast L (kg)	110
Belt operating capacity (kg)	417
Belt breaking load (kg)	1615
Command type	Remote control
Battery type	2 AGM 24 V - 9 Ah
Total battery weight (kg)	4,85
Charger	External - 230 V - 50-60Hz
Number of cycles	80-150 cycles
Battery indicator	On the remote control unit
Recharge time	7,50h for 100%
Front wheel	Double Ø 75 - swivel
Rear wheel	Ø 125 - with central brake

REFERENCE	TROLLEY	LENGTH OF LEGS	WIDTH OF LEGS	TOTAL HEIGHT	LIFTING STROKE	WEIGHT
WPR-125-2120-SS	WP 125S-SS-S-500	500	530	1560	1220	63
WPR-125-2130-SS	WP 125S-SS-S-650	650	530	1560	1220	64
WPR-125-2220-SS	WP 125S-SS-C-500	500	146	1560	1220	63
WPR-125-3120-SS	WP 125M-SS-S-500	500	530	1940	1600	65
WPR-125-3130-SS	WP 125M-SS-S-650	650	530	1940	1600	66
WPR-125-3220-SS	WP 125M-SS-C-500	500	146	1940	1600	65
WPR-125-4120-SS	WP 125L-SS-S-500	500	530	2390	2050	68
WPR-125-4130-SS	WP 125L-SS-S-650	650	530	2390	2050	69

LOAD DIAGRAM

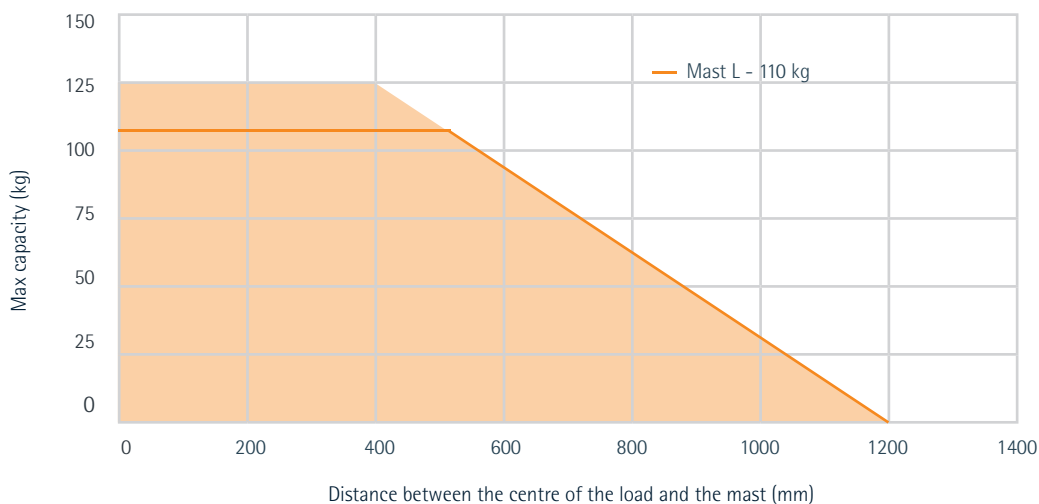

WORK POSITIONER WP 125 SS

ORDERING INFORMATION

REMOTE CONTROL	REFERENCE
ERGOCONTROL handle in stainless steel with 1 button	WPR-RO-SS
ERGOCONTROL handle Remote with function up and down	WPR-R1
ERGOCONTROL handle Remote with function up and down + option automatic level / positioner	WPR-R2
ERGOCONTROL handle Remote + clamping + tilting	WPR-R3
ERGOCONTROL handle Remote with function up and down + clamping + rotation	WPR-R4
ERGOCONTROL handle Remote with function up and down + rotation	WPR-R5
ERGOCONTROL handle Remote with function up and down + clamping	WPR-R6
ERGOCONTROL handle Remote with function up and down + tilting	WPR-R7

OPTIONS	REFERENCE
Automatic level option with unit cell in a casing	WPR-O-0001
Positioner system with multiple position	WPR-O-0002
2 additional AGM battery WP 125*	WPR-O-0003
Replacement of 2 AGM batteries by 2 lithium batteries	WPR-O-0004
2 Additional lithium battery	WPR-O-0006
1 Additional electric function*	WPR-O-0007
2 Additional electric functions*	WPR-O-0008
Lateral rollers for tool holder carriage*	WPR-O-0010-SS
Charger storage case - SS	WPR-O-0011-SS
Legs enlargement between 530 and 800 mm WP 125 - SS	WPR-O-0013-SS
Width reduction of the legs between standard and central legs width	WPR-O-0016
Mast height custom fit (between smallest & highest mast)*	WPR-O-0019
Legs length custom fit between 150 and 650 mm WP 125	WPR-O-0017
Fixed front wheel Ø 75 mm - for WP 125 - SS	WPR-O-0025-SS
Conductive option on WP55 to WPI25 with ESD rear wheel Ø125 - individual brake	WPR-O-0027
Conductive option on WP55 to WPI25 with ESD rear wheel Ø125- central brake	WPR-O-0028
Rear wheel with individual brake for WP 125-SS - STD 500mm - replacement of the central brake	WPR-O-0048-SS
Rear wheel with individual brake for WP 125-SS - STD 650mm - replacement of the central brake	WPR-O-0049-SS
Rear wheel with individual brake for WP 125-SS - Central - replacement of the central brake	WPR-O-0050-SS
Front swivelling wheels Ø 125 mm - SS	WPR-O-0031-SS
Counterweight 25 kg - WP 125 - SS	WPR-O-0034-SS
Counterweight 5 kg - WP 125 - SS	WPR-O-0035-SS
3 Steps ladder with rotation on mast	WPR-O-0038-SS
Integration of 1 replaceable battery pack up to 2 cells + charging station	WPR-O-0039
Additional AGM battery pack - 2 cells lead acid	WPR-O-0041
Additional lithium battery pack - 2 lithium cells	WPR-O-0043
Charging station for replaceable battery pack	WPR-O-0045

TOOLS	REFERENCE
Boom with wheel + V-Support 360°	WPR-T-0001
Boom with wheel + V-Support 360° - SS	WPR-T-0001-SS
Boom with wheel for V-support	WPR-T-0002
Boom with wheel for V-support - Customizable	WPR-T-9002
Boom with wheel for V-support - SS	WPR-T-0002-SS
Boom with wheel for V-support - Customizable - SS	WPR-T-9002-SS
V-Support	WPR-T-0003
V-Support - Customizable	WPR-T-9003
V-Support - SS	WPR-T-0003-SS
V-Support - Customizable - SS	WPR-T-9003-SS

TOOLS	REFERENCE
Boom - tube Ø 60 - Length 500 mm	WPR-T-0004
Boom tube Ø 60 - Customizable	WPR-T-9004
Boom - tube Ø 60 - Length 500 mm - SS	WPR-T-0004-SS
Boom tube Ø 60 - Customizable - SS	WPR-T-9004-SS
Boom - tube Ø 35 - Customizable	WPR-T-9005
Boom - tube Ø 35 - Customizable - SS	WPR-T-9005-SS
Double boom - tube Ø 35 - Length 500 mm	WPR-T-0006
Double boom - tube Ø 35 - Customizable	WPR-T-9006
Double boom tube Ø 35 - Length 500 mm - SS	WPR-T-0006-SS
Double boom - tube Ø 35 - Customizable - SS	WPR-T-9006-SS
Platform stainless steel - steel frame - 500 x 500 mm - 60 kg	WPR-T-0007
Platform stainless steel - stainless steel frame - 500 x 500 mm - 60 kg	WPR-T-0007-SS
Platform stainless steel - steel frame - 500 x 500 mm - 85 kg	WPR-T-0008
Platform stainless steel - steel frame - Customizable - 85 kg	WPR-T-9008
Platform stainless steel - stainless steel frame - 500 x 500 mm - 85 kg	WPR-T-0008-SS
Platform stainless steel - stainless steel frame - Customizable - 85 kg	WPR-T-9008-SS
Platform HDPE - steel frame - 500 x 500 mm - 60 kg	WPR-T-0010
Platform HDPE - stainless steel frame - 500 x 500 mm - 60 kg	WPR-T-0010-SS
Platform HDPE - steel frame - 500 x 500 mm - 85 kg	WPR-T-0011
Platform HDPE - steel frame - Customizable - 85 kg	WPR-T-9011
Platform HDPE - stainless steel frame - 500 x 500 mm - 85 kg	WPR-T-0011-SS
Platform HDPE - stainless steel frame - Customizable - 85 kg	WPR-T-9011-SS
Platform HDPE with rolls - 500 x 500 mm - steel frame - 85 kg	WPR-T-0012
Platform HDPE with rolls - 500 x 500 mm - stainless steel frame - 80 kg	WPR-T-0012-SS
Platform HDPE - steel frame - 500 x 500 mm - 200 kg	WPR-T-0013
Platform HDPE - stainless steel frame - 500 x 500 mm - 200 kg	WPR-T-0013-SS
Platform HDPE - steel frame - Customizable - 200 kg	WPR-T-9013
Platform HDPE - stainless steel frame - Customizable - 200 kg	WPR-T-9013-SS
Wave Platform - 80 kg	WPR-T-0014
Wave Platform - 80 kg - SS	WPR-T-0014-SS
Crane arm with adjustable hook support - 200 kg	WPR-T-0015
Crane arm with adjustable hook support - 180 kg - Customizable	WPR-T-9015
Crane arm with adjustable hook support - 200 kg - SS	WPR-T-0015-SS
Crane arm with adjustable hook support - 180 kg - Customizable - SS	WPR-T-9015-SS
Fork - 160kg - Customizable	WPR-T-9016
Fork - 160kg - Customizable - SS	WPR-T-9016-SS
Adjustable fork - length 610 mm - 85 kg	WPR-T-0018
Adjustable fork - length 610 mm - 85 kg - SS	WPR-T-0018-SS
Symmetric adjustable fork - 180 kg - Customizable	WPR-T-9019
Symmetric adjustable fork - 180 kg - Customizable - SS	WPR-T-9019-SS
4-cleat fork - 100 kg - Customizable	WPR-T-9020-SS
8-cleat fork - 140 kg - Customizable	WPR-T-9021-SS
8-cleat fork with adjustable width - 100 kg - Customizable	WPR-T-9038-SS
Legs Covering fork - 100 kg	WPR-T-9022
Legs Covering fork - 100 kg - SS	WPR-T-9022-SS
Fork for gripping rolling tray for EU std Bins -150 kg	WPR-T-9023
Fork for gripping rolling tray for EU std Bins - 150 kg - SS	WPR-T-9023-SS
Manual front tilting gripper for drums - 80 kg	WPR-T-9026
Manual front tilting gripper for drums - 80 kg - SS	WPR-T-9026-SS
Manual core gripper with tilting 90° for reel - core Ø 76 mm - 80 kg - SS	WPR-T-0028-SS

WORK POSITIONER WP 125 SS



ORDERING INFORMATION

TOOLS	REFERENCE
Extended manual core gripper with tilting 90° for reel - core Ø 76 mm - 80 kg - SS	WPR-T-0034-SS
Vertical core gripper for reel core Ø 76 mm - 80kg - SS	WPR-T-0029-SS
Electric core gripper with tilting 90° for reel core Ø 76 mm - 110kg - SS*	WPR-T-0030-SS
Electric clamp - 100 kg - SS*	WPR-T-0031-SS
Electric clamp with rotation system - 100 kg - SS*	WPR-T-0032-SS

ACCESSORIES	REFERENCE
Quick change tooling - trolley part - 125 kg - SS	WPR-A-0001-SS
Quick Change tooling - Tool Part - 125 kg - SS	WPR-A-0002-SS
Quick change tooling - trolley part - 205 kg - SS	WPR-A-0003-SS
Quick change tooling - tool part - 205 kg - SS	WPR-A-0004-SS
Tool attachment elevation - 150-500 mm	WPR-A-9005
Tool attachment elevation - 150-500 mm - SS	WPR-A-9005-SS
Lateral translator ± 200 mm	WPR-A-0006
Weighting system on crane - 200 kg	WPR-A-0007-SS
Height position marking	WPR-A-0008
Snap Hook Ø 6 - SS	WPR-A-0009-SS
Snap Hook Ø 8 - SS	WPR-A-0010-SS
Lifting chain - 1 m - SS	WPR-A-0011-SS
Safety shackle	WPR-A-0012
Safety shackle - SS	WPR-A-0012-SS
Latch hook	WPR-A-0013
Latch hook - SS	WPR-A-0013-SS
360° Latch hook	WPR-A-0014
Platform rollers Ø 50 mm with 2 fixation pieces SS	WPR-A-0015-SS
Platform edges - SS	WPR-A-0016-SS
Extension for expandable hub Ø 76 mm - SS	WPR-A-0017-SS
Core gripper adapter for reel with core Ø 150 mm	WPR-A-0018-SS
Adjustable Crane Crossbar 60 x 40 - 600 mm	WPR-A-0019
Adjustable Crane Crossbar 60 x 40 - Customizable	WPR-A-9019
Adjustable Crane Crossbar - 600 mm - SS	WPR-A-0019-SS
Adjustable crane crossbar - Customizable - SS	WPR-A-9019-SS
End stops on forks	WPR-A-0020
End stops on forks - SS	WPR-A-0020-SS
Short clamping jaws with 2 rollers*	WPR-A-0021-SS
Long clamping jaws with 2 rollers*	WPR-A-0022-SS
Articulated clamping jaws with 4 rollers*	WPR-A-0023-SS
Jaws with adapted form to bespoke diameter*	WPR-A-9024-SS
Manual rotation system - 100 kg - SS	WPR-A-0026-SS
Electric rotation System - 150 kg - SS*	WPR-A-0027-SS
Plate with indexing pin for 90° locking of the V platform.	WPR-A-0028-SS
Ball-screw indexing plate for 90° locking of V-platform.	WPR-A-0029-SS



WORK POSITIONER
WP 125
CMAU

CMAU
125 KG

39
DENLOP
FLEXOR

WP 125 SS

WORK POSITIONER WP 205

DESCRIPTION



An industrial trolley for heavy loads

The WP 205 lift trolley is designed to move, lift and turn any type of loads. This lifting trolley can be equipped with different electrical tools, making it particularly suitable for handling drums or large reels.

Thanks to its interchangeable batteries*, the WP 205 lift trolley is a tool suitable for large industries and 24-hour shift work. The WP 205 is a trolley adapted to the aeronautics, various industries, and logistics sectors. The trolley has a battery indicator on the remote control, it is simple for the user to know the battery level of his handling trolley.

The WP 205 lift trolley is equipped with various safety features. It has overload protection, a safety clutch and a soft start to facilitate the handling of all types of loads. Practical in workshops, the wheels of the trolley are easily recognizable thanks to their red color and reduces the risk of falling.

**(possible option)*

The model WP 205 has a total capacity of **205 kg**, at a distance of 400 mm from the mast.

The WP 205 is delivered with **AGM batteries** (24 V ; 18 Ah) as standard.

The motor speed is **120 mm/s**.

TECHNICAL SPECIFICATIONS

DESCRIPTION	WP 205
Max capacity mast S & M (kg)	205
Max capacity mast L (kg)	180
Belt operating capacity (kg)	539
Belt breaking load (kg)	2090
Command type	Remote control
Battery type	4 AGM (Tot : 24 V - 18 Ah)
Total battery weight (kg)	9.7
Charger	External - 230 V - 50-60Hz
Number of cycles	80-150 cycles
Battery indicator	On the remote control unit
Recharge time	15h for 100%
Front wheel	Simple Ø 80 - fixed
Rear wheel	Ø 150 - with central brake

REFERENCE	TROLLEY	LENGTH OF LEGS	WIDTH OF LEGS	TOTAL HEIGHT	LIFTING STROKE	WEIGHT
WPR-205-2121	WP 205S-S-500	500	520	1560	1180	86
WPR-205-2131	WP 205S-S-650	650	520	1560	1180	87
WPR-205-2221	WP 205S-C-500	500	146	1560	1180	86
WPR-205-3121	WP 205M-S-500	500	520	1940	1560	89
WPR-205-3131	WP 205M-S-650	650	520	1940	1560	90
WPR-205-3221	WP 205M-C-500	500	146	1940	1560	89
WPR-205-4121	WP 205L-S-500	500	520	2390	2000	94
WPR-205-4131	WP 205L-S-650	650	520	2390	2000	95

▶ LOAD DIAGRAM

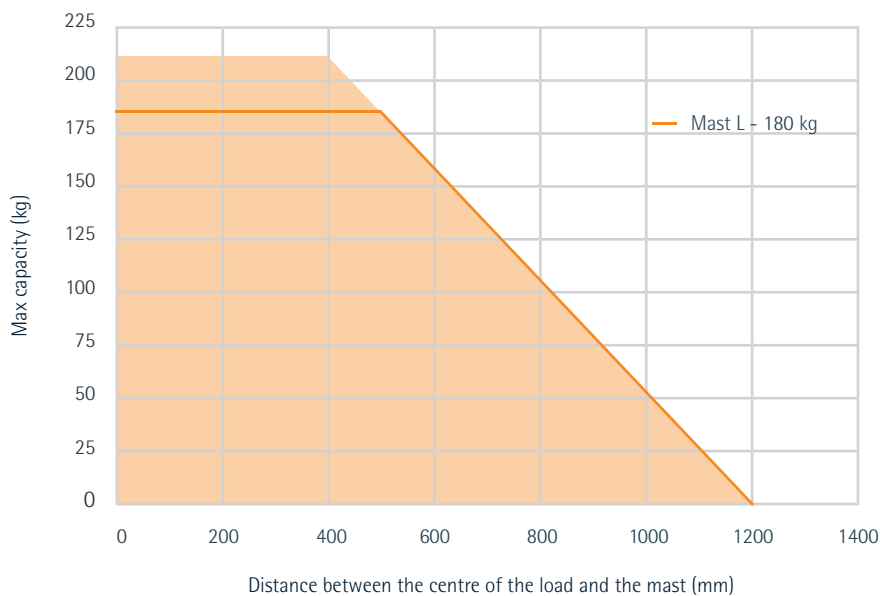

WORK POSITIONER WP 205

ORDERING INFORMATION

REMOTE CONTROL	REFERENCE
ERGOCONTROL handle with 1 button	WPR-R0
ERGOCONTROL handle Remote with function up and down	WPR-R1
ERGOCONTROL handle Remote with function up and down + option automatic level / positioner	WPR-R2
ERGOCONTROL handle Remote + clamping + tilting	WPR-R3
ERGOCONTROL handle Remote with function up and down + clamping + rotation	WPR-R4
ERGOCONTROL handle Remote with function up and down + rotation	WPR-R5
ERGOCONTROL handle Remote with function up and down + clamping	WPR-R6
ERGOCONTROL handle Remote with function up and down + tilting	WPR-R7

OPTIONS	REFERENCE
Automatic level option with unit cell in a casing	WPR-O-0001
Positioner system with multiple position	WPR-O-0002
Replacement of 4 AGM batteries by 2 lithium batteries	WPR-O-0005
2 Additional lithium battery	WPR-O-0006
1 Additional electric function*	WPR-O-0007
2 Additional electric functions*	WPR-O-0008
Lateral rollers for tool holder carriage*	WPR-O-0010-SS
Charger storage case	WPR-O-0011
Legs enlargement between 530 and 800 mm WP 205	WPR-O-0014
Width reduction of the legs between standard and central legs width	WPR-O-0016
Mast height custom fit (between smallest & highest mast)*	WPR-O-0019
Legs length custom fit between 150 and 650 mm WP 205	WPR-O-0018
Swivelling front wheel Ø 75 mm - for WP 205*	WPR-O-0026
Conductive option on WP205 with ESD rear wheel Ø150 - individual brake	WPR-O-0029
Conductive option on WP205 with ESD rear wheel Ø150 - central brake	WPR-O-0030
Front swivelling wheels Ø 125 mm	WPR-O-0031
Rear wheel with individual brake for WP 205 - STD 500mm - replacement of the central brake	WPR-O-0051
Rear wheel with individual brake for WP 205 - STD 650mm - replacement of the central brake	WPR-O-0052
Rear wheel with individual brake for WP 205 - Central - replacement of the central brake	WPR-O-0053
Counterweight 25 kg - WP 205	WPR-O-0036
Counterweight 5 kg - WP 205	WPR-O-0037
3 Steps ladder with rotation on mast	WPR-O-0038-SS
Integration of 1 replaceable battery pack up to 2 cells + charging station	WPR-O-0039
Integration of 1 replaceable battery pack up to 4 cells + charging station	WPR-O-0040
Additional AGM battery pack - 2 cells lead acid	WPR-O-0041
Additional AGM battery pack - 4 cells lead acid	WPR-O-0042
Additional lithium battery pack - 2 lithium cells	WPR-O-0043
Additional lithium battery pack - 4 lithium cells	WPR-O-0044
Charging station for replaceable battery pack	WPR-O-0045
EWA: Electric Wheel Assistance for WP 205 - AGM - Steel	WPR-O-EWA-205
EWA: Electric Wheel Assistance for WP 205 - Lithium - Steel	WPR-O-EWA-205-LI
Rear wheel with individual brake for WP 125 - STD 500mm - replacement of the central brake	WPR-O-0048
Rear wheel with individual brake for WP 125 - STD 650mm - replacement of the central brake	WPR-O-0049
Rear wheel with individual brake for WP 125 - Central - replacement of the central brake	WPR-O-0050

TOOLS	REFERENCE
Boom with wheel + V-Support 360°	WPR-T-0001
Boom with wheel + V-Support 360° - SS	WPR-T-0001-SS
Boom with wheel for V-support	WPR-T-0002
Boom with wheel for V-support - Customizable	WPR-T-9002

TOOLS	REFERENCE
Boom with wheel for V-support - SS	WPR-T-0002-SS
Boom with wheel for V-support - Customizable - SS	WPR-T-9002-SS
V-Support	WPR-T-0003
V-Support - Customizable	WPR-T-9003
V-Support - SS	WPR-T-0003-SS
V-Support - Customizable - SS	WPR-T-9003-SS
Boom - tube Ø 60 - Length 500 mm	WPR-T-0004
Boom tube Ø 60 - Customizable	WPR-T-9004
Boom - tube Ø 60 - Length 500 mm - SS	WPR-T-0004-SS
Boom tube Ø 60 - Customizable - SS	WPR-T-9004-SS
Boom - tube Ø 35 - Customizable	WPR-T-9005
Boom - tube Ø 35 - Customizable - SS	WPR-T-9005-SS
Double boom - tube Ø 35 - Length 500 mm	WPR-T-0006
Double boom - tube Ø 35 - Customizable	WPR-T-9006
Double boom tube Ø 35 - Length 500 mm - SS	WPR-T-0006-SS
Double boom - tube Ø 35 - Customizable - SS	WPR-T-9006-SS
Platform stainless steel - steel frame - 500 x 500 mm - 60 kg	WPR-T-0007
Platform stainless steel - stainless steel frame - 500 x 500 mm - 60 kg	WPR-T-0007-SS
Platform stainless steel - steel frame - 500 x 500 mm - 85 kg	WPR-T-0008
Platform stainless steel - steel frame - Customizable - 85 kg	WPR-T-9008
Platform stainless steel - stainless steel frame - 500 x 500 mm - 85 kg	WPR-T-0008-SS
Platform stainless steel - stainless steel frame - Customizable - 85 kg	WPR-T-9008-SS
Platform stainless steel - steel frame - 500 x 500 mm - 200 kg	WPR-T-0009
Platform stainless steel - steel frame - 200 kg - Customizable	WPR-T-9009
Platform stainless steel - stainless steel frame - 500 x 500 mm - 200 kg	WPR-T-0009-SS
Platform stainless steel - stainless steel frame - 200 kg - Customizable	WPR-T-9009-SS
Platform HDPE - steel frame - 500 x 500 mm - 60 kg	WPR-T-0010
Platform HDPE - stainless steel frame - 500 x 500 mm - 60 kg	WPR-T-0010-SS
Platform HDPE - steel frame - 500 x 500 mm - 85 kg	WPR-T-0011
Platform HDPE - steel frame - Customizable - 85 kg	WPR-T-9011
Platform HDPE - stainless steel frame - 500 x 500 mm - 85 kg	WPR-T-0011-SS
Platform HDPE - stainless steel frame - Customizable - 85 kg	WPR-T-9011-SS
Platform HDPE with rolls - 500 x 500 mm - steel frame - 85 kg	WPR-T-0012
Platform HDPE with rolls - 500 x 500 mm - stainless steel frame - 80 kg	WPR-T-0012-SS
Platform HDPE - steel frame - 500 x 500 mm - 200 kg	WPR-T-0013
Platform HDPE - stainless steel frame - 500 x 500 mm - 200 kg	WPR-T-0013-SS
Platform HDPE - steel frame - Customizable - 200 kg	WPR-T-9013
Platform HDPE - stainless steel frame - Customizable - 200 kg	WPR-T-9013-SS
Wave Platform - 80 kg	WPR-T-0014
Wave Platform - 80 kg - SS	WPR-T-0014-SS
Wave Platform with rollers - 160 kg	WPR-T-9039
Wave Platform with rollers - 160 kg - SS	WPR-T-9039-SS
Crane arm with adjustable hook support - 200 kg	WPR-T-0015
Crane arm with adjustable hook support - 180 kg - Customizable	WPR-T-9015
Crane arm with adjustable hook support - 200 kg - SS	WPR-T-0015-SS
Crane arm with adjustable hook support - 180 kg - Customizable - SS	WPR-T-9015-SS
Fork - 160kg - Customizable	WPR-T-9016
Fork - 160kg - Customizable - SS	WPR-T-9016-SS
Adjustable fork - length 610 mm - 85 kg	WPR-T-0018
Adjustable fork - length 610 mm - 85 kg - SS	WPR-T-0018-SS
Reinforced Adjustable fork - length 650 mm -160 kg	WPR-T-0033
Reinforced Adjustable fork -120 kg - Customizable	WPR-T-9033
Reinforced Adjustable fork - length 650 mm - 160 kg - SS	WPR-T-0033-SS
Reinforced Adjustable fork - 120 kg - Customizable - SS	WPR-T-9033-SS
Symmetric adjustable fork - 180 kg - Customizable	WPR-T-9019
Symmetric adjustable fork - 180 kg - Customizable - SS	WPR-T-9019-SS
4-cleat fork - 100 kg - Customizable	WPR-T-9020-SS
8-cleat fork - 140 kg - Customizable	WPR-T-9021-SS

WORK POSITIONER WP 205

ORDERING INFORMATION

TOOLS	REFERENCE
8-cleat fork with adjustable width - 100 kg - Customizable	WPR-T-9038-SS
Legs Covering fork - 100 kg	WPR-T-9022
Legs Covering fork - 100 kg - SS	WPR-T-9022-SS
Fork for gripping rolling tray for EU std Bins -150 kg	WPR-T-9023
Fork for gripping rolling tray for EU std Bins - 150 kg - SS	WPR-T-9023-SS
Articulated Core Gripper for wrapping reel - 50 kg	WPR-T-0025
Manual front tilting gripper for drums - 80 kg	WPR-T-9026
Manual front tilting gripper for drums - 80 kg - SS	WPR-T-9026-SS
Manual side tilting gripper for waste bin - Customizable - 80 kg	WPR-T-9027
Manual core gripper with tilting 90° for reel - core Ø 76 mm - 80 kg - SS	WPR-T-0028-SS
Extended manual core gripper with tilting 90° for reel - core Ø 76 mm - 80 kg - SS	WPR-T-0034-SS
Vertical core gripper for reel core Ø 76 mm - 80kg - SS	WPR-T-0029-SS
Electric core gripper with tilting 90° for reel core Ø 76 mm - 110kg - SS*	WPR-T-0030-SS
Electric clamp - 100 kg - SS*	WPR-T-0031-SS
Electric clamp with rotation system - 100 kg - SS*	WPR-T-0032-SS

ACCESSORIES	REFERENCE
Quick change tooling - trolley part - 205 kg - SS	WPR-A-0003-SS
Quick change tooling - tool part - 205 kg - SS	WPR-A-0004-SS
Tool attachment elevation - 150-500 mm	WPR-A-9005
Tool attachment elevation - 150-500 mm - SS	WPR-A-9005-SS
Lateral translator ± 200 mm	WPR-A-0006
Weighting system on crane - 200 kg	WPR-A-0007-SS
Height position marking	WPR-A-0008
Snap Hook Ø 6 - SS	WPR-A-0009-SS
Snap Hook Ø 8 - SS	WPR-A-0010-SS
Lifting chain - 1 m - SS	WPR-A-0011-SS
Safety shackle	WPR-A-0012
Safety shackle - SS	WPR-A-0012-SS
Latch hook	WPR-A-0013
Latch hook - SS	WPR-A-0013-SS
360° Latch hook	WPR-A-0014
Platform rollers Ø 50 mm with 2 fixation pieces SS	WPR-A-0015-SS
Platform edges - SS	WPR-A-0016-SS
Extension for expandable hub Ø 76 mm - SS	WPR-A-0017-SS
Core gripper adapter for reel with core Ø 150 mm	WPR-A-0018-SS
Adjustable Crane Crossbar 60 x 40 - 600 mm	WPR-A-0019
Adjustable Crane Crossbar 60 x 40 - Customizable	WPR-A-9019
Adjustable Crane Crossbar - 600 mm - SS	WPR-A-0019-SS
Adjustable crane crossbar - Customizable - SS	WPR-A-9019-SS
End stops on forks	WPR-A-0020
End stops on forks - SS	WPR-A-0020-SS
Short clamping jaws with 2 rollers*	WPR-A-0021-SS
Long clamping jaws with 2 rollers*	WPR-A-0022-SS
Articulated clamping jaws with 4 rollers*	WPR-A-0023-SS
Jaws with adapted form to bespoke diameter*	WPR-A-9024-SS
Manual rotation system - 100 kg - SS	WPR-A-0026-SS
Electric rotation System - 150 kg - SS*	WPR-A-0027-SS
Plate with indexing pin for 90° locking of the V platform.	WPR-A-0028-SS



WORK POSITIONER WP 205 SS

DESCRIPTION



Stainless
Steel



Class II



IP 65

Water resistant for perfect hygiene

Our WP 205 stainless steel lift trolley is powerful equipment that can be equipped with electrical tools for handling loads up to 205 kg.

With a wide selection of stainless steel tools such as platform, boom, forks, grippers and clamps, our trolleys can handle most loads. The trolley can grip, tilt and lift your loads up to a lifting stroke of 200 cm.

Equipped with an ergonomic handle, it is adapted to different morphologies and makes the handling of heavy loads easy.

Thanks to its interchangeable batteries* it can operate 24 hours a day.

**(possible option)*

The model WP 205 SS has a total capacity of **205 kg**, at a distance of 400mm from the mast.

The WP 205 SS is delivered with **AGM batteries** (24 V ; 18 Ah) as standard.

The motor speed is **120 mm/s**.

TECHNICAL SPECIFICATIONS

DESCRIPTION	WP 205 SS
Max capacity mast S & M (kg)	205
Max capacity mast L (kg)	180
Belt operating capacity (kg)	539
Belt breaking load (kg)	2090
Command type	Remote control
Battery type	4 AGM (Tot : 24 V - 18 Ah)
Total battery weight (kg)	9,7
Charger	External - 230 V - 50-60Hz
Number of cycles	80-150 cycles
Battery indicator	On the remote control unit
Recharge time	15h for 100%
Front wheel	Simple Ø 80 - fixed
Rear wheel	Ø 150 - with central brake

REFERENCE	TROLLEY	LENGTH OF LEGS	WIDTH OF LEGS	TOTAL HEIGHT	LIFTING STROKE	WEIGHT
WPR-205-2121-SS	WP 205S-SS-S-500	500	520	1560	1180	86
WPR-205-2131-SS	WP 205S-SS-S-650	650	520	1560	1180	87
WPR-205-2221-SS	WP 205S-SS-C-500	500	146	1560	1180	86
WPR-205-3121-SS	WP 205M-SS-S-500	500	520	1940	1560	90
WPR-205-3131-SS	WP 205M-SS-S-650	650	520	1940	1560	91
WPR-205-3221-SS	WP 205M-SS-C-500	500	146	1940	1560	90
WPR-205-4121-SS	WP 205L-SS-S-500	500	520	2390	2000	93
WPR-205-4131-SS	WP 205L-SS-S-650	650	520	2390	2000	94

LOAD DIAGRAM

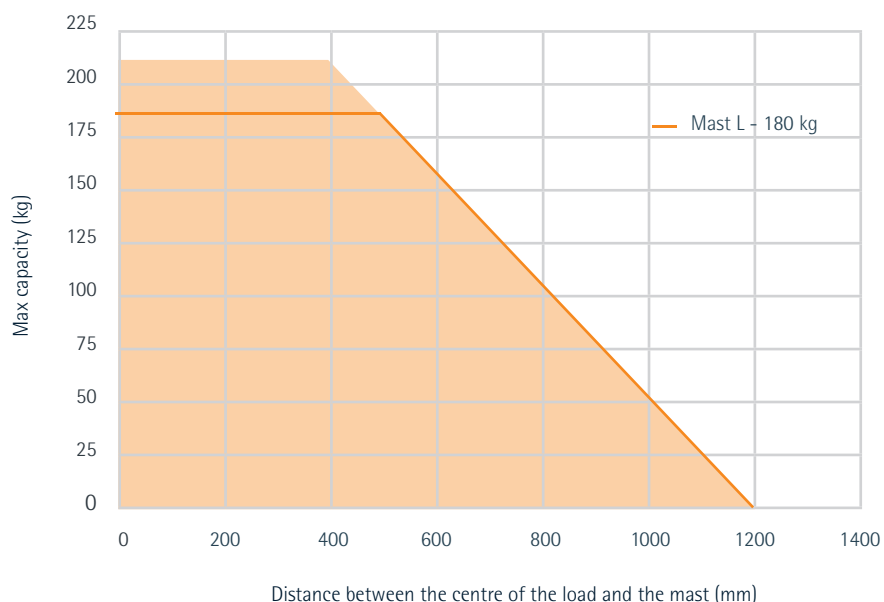

WORK POSITIONER WP 205 SS

ORDERING INFORMATION

REMOTE CONTROL	REFERENCE
ERGOCONTROL handle in stainless steel with 1 button	WPR-RO-SS
ERGOCONTROL handle Remote with function up and down	WPR-R1
ERGOCONTROL handle Remote with function up and down + option automatic level / positioner	WPR-R2
ERGOCONTROL handle Remote + clamping + tilting	WPR-R3
ERGOCONTROL handle Remote with function up and down + clamping + rotation	WPR-R4
ERGOCONTROL handle Remote with function up and down + rotation	WPR-R5
ERGOCONTROL handle Remote with function up and down + clamping	WPR-R6
ERGOCONTROL handle Remote with function up and down + tilting	WPR-R7

OPTIONS	REFERENCE
Automatic level option with unit cell in a casing	WPR-O-0001
Positioner system with multiple position	WPR-O-0002
Replacement of 4 AGM batteries by 2 lithium batteries	WPR-O-0005
2 Additional lithium battery	WPR-O-0006
1 Additional electric function*	WPR-O-0007
2 Additional electric functions*	WPR-O-0008
Lateral rollers for tool holder carriage*	WPR-O-0010-SS
Charger storage case - SS	WPR-O-0011-SS
Legs enlargement between 530 and 800 mm WP 205 - SS	WPR-O-0014-SS
Width reduction of the legs between standard and central legs width	WPR-O-0016
Mast height custom fit (between smallest & highest mast)*	WPR-O-0019
Legs length custom fit between 150 and 650 mm WP 205	WPR-O-0018
Swivelling front wheel Ø 75 mm - for WP 205 - SS*	WPR-O-0026-SS
Conductive option on WP205 with ESD rear wheel Ø150 - individual brake	WPR-O-0029
Conductive option on WP205 with ESD rear wheel Ø150 - central brake	WPR-O-0030
Front swivelling wheels Ø 125 mm - SS	WPR-O-0031-SS
Rear wheel with individual brake for WP 205-SS - STD 500mm - replacement of the central brake	WPR-O-0051-SS
Rear wheel with individual brake for WP 205-SS - STD 650mm - replacement of the central brake	WPR-O-0052-SS
Rear wheel with individual brake for WP 205-SS - Central - replacement of the central brake	WPR-O-0053-SS
Counterweight 25 kg - WP 205 - SS	WPR-O-0036-SS
Counterweight 5 kg - WP 205 - SS	WPR-O-0037-SS
3 Steps ladder with rotation on mast	WPR-O-0038-SS
Integration of 1 replaceable battery pack up to 2 cells + charging station	WPR-O-0039
Integration of 1 replaceable battery pack up to 4 cells + charging station	WPR-O-0040
Additional AGM battery pack - 2 cells lead acid	WPR-O-0041
Additional AGM battery pack - 4 cells lead acid	WPR-O-0042
Additional lithium battery pack - 2 lithium cells	WPR-O-0043
Additional lithium battery pack - 4 lithium cells	WPR-O-0044
Charging station for replaceable battery pack	WPR-O-0045
Rear wheel with individual brake for WP 125-SS - STD 500mm - replacement of the central brake	WPR-O-0048-SS
Rear wheel with individual brake for WP 125-SS - STD 650mm - replacement of the central brake	WPR-O-0049-SS
Rear wheel with individual brake for WP 125-SS - Central - replacement of the central brake	WPR-O-0050-SS

TOOLS	REFERENCE
Boom with wheel + V-Support 360°	WPR-T-0001
Boom with wheel + V-Support 360° - SS	WPR-T-0001-SS
Boom with wheel for V-support	WPR-T-0002
Boom with wheel for V-support - Customizable	WPR-T-9002
Boom with wheel for V-support - SS	WPR-T-0002-SS
Boom with wheel for V-support - Customizable - SS	WPR-T-9002-SS

TOOLS	REFERENCE
V-Support	WPR-T-0003
V-Support - Customizable	WPR-T-9003
V-Support - SS	WPR-T-0003-SS
V-Support - Customizable - SS	WPR-T-9003-SS
Boom - tube Ø 60 - Length 500 mm	WPR-T-0004
Boom tube Ø 60 - Customizable	WPR-T-9004
Boom - tube Ø 60 - Length 500 mm - SS	WPR-T-0004-SS
Boom tube Ø 60 - Customizable - SS	WPR-T-9004-SS
Boom - tube Ø 35 - Customizable	WPR-T-9005
Boom - tube Ø 35 - Customizable - SS	WPR-T-9005-SS
Double boom - tube Ø 35 - Length 500 mm	WPR-T-0006
Double boom - tube Ø 35 - Customizable	WPR-T-9006
Double boom tube Ø 35 - Length 500 mm - SS	WPR-T-0006-SS
Double boom - tube Ø 35 - Customizable - SS	WPR-T-9006-SS
Platform stainless steel - steel frame - 500 x 500 mm - 60 kg	WPR-T-0007
Platform stainless steel - stainless steel frame - 500 x 500 mm - 60 kg	WPR-T-0007-SS
Platform stainless steel - steel frame - 500 x 500 mm - 85 kg	WPR-T-0008
Platform stainless steel - steel frame - Customizable - 85 kg	WPR-T-9008
Platform stainless steel - stainless steel frame - 500 x 500 mm - 85 kg	WPR-T-0008-SS
Platform stainless steel - stainless steel frame - Customizable - 85 kg	WPR-T-9008-SS
Platform stainless steel - steel frame - 500 x 500 mm - 200 kg	WPR-T-0009
Platform stainless steel - steel frame - 200 kg - Customizable	WPR-T-9009
Platform stainless steel - stainless steel frame - 500 x 500 mm - 200 kg	WPR-T-0009-SS
Platform stainless steel - stainless steel frame - 200 kg - Customizable	WPR-T-9009-SS
Platform HDPE - steel frame - 500 x 500 mm - 60 kg	WPR-T-0010
Platform HDPE - stainless steel frame - 500 x 500 mm - 60 kg	WPR-T-0010-SS
Platform HDPE - steel frame - 500 x 500 mm - 85 kg	WPR-T-0011
Platform HDPE - steel frame - Customizable - 85 kg	WPR-T-9011
Platform HDPE - stainless steel frame - 500 x 500 mm - 85 kg	WPR-T-0011-SS
Platform HDPE - stainless steel frame - Customizable - 85 kg	WPR-T-9011-SS
Platform HDPE with rolls - 500 x 500 mm - steel frame - 85 kg	WPR-T-0012
Platform HDPE with rolls - 500 x 500 mm - stainless steel frame - 80 kg	WPR-T-0012-SS
Platform HDPE - steel frame - 500 x 500 mm - 200 kg	WPR-T-0013
Platform HDPE - stainless steel frame - 500 x 500 mm - 200 kg	WPR-T-0013-SS
Platform HDPE - steel frame - Customizable - 200 kg	WPR-T-9013
Platform HDPE - stainless steel frame - Customizable - 200 kg	WPR-T-9013-SS
Wave Platform - 80 kg	WPR-T-0014
Wave Platform - 80 kg - SS	WPR-T-0014-SS
Wave Platform with rollers - 160 kg	WPR-T-9039
Wave Platform with rollers - 160 kg - SS	WPR-T-9039-SS
Crane arm with adjustable hook support - 200 kg	WPR-T-0015
Crane arm with adjustable hook support - 180 kg - Customizable	WPR-T-9015
Crane arm with adjustable hook support - 200 kg - SS	WPR-T-0015-SS
Crane arm with adjustable hook support - 180 kg - Customizable - SS	WPR-T-9015-SS
Fork - 160kg - Customizable	WPR-T-9016
Fork - 160kg - Customizable - SS	WPR-T-9016-SS
Adjustable fork - length 610 mm - 85 kg	WPR-T-0018
Adjustable fork - length 610 mm - 85 kg - SS	WPR-T-0018-SS
Reinforced Adjustable fork - length 650 mm -160 kg	WPR-T-0033
Reinforced Adjustable fork -120 kg - Customizable	WPR-T-9033
Reinforced Adjustable fork - length 650 mm - 160 kg - SS	WPR-T-0033-SS
Reinforced Adjustable fork - 120 kg - Customizable - SS	WPR-T-9033-SS
Symmetric adjustable fork - 180 kg - Customizable	WPR-T-9019
Symmetric adjustable fork - 180 kg - Customizable - SS	WPR-T-9019-SS
4-cleat fork - 100 kg - Customizable	WPR-T-9020-SS
8-cleat fork - 140 kg - Customizable	WPR-T-9021-SS
8-cleat fork with adjustable width - 100 kg - Customizable	WPR-T-9038-SS

WORK POSITIONER WP 205 SS

ORDERING INFORMATION

TOOLS	REFERENCE
Legs Covering fork - 100 kg	WPR-T-9022
Legs Covering fork - 100 kg - SS	WPR-T-9022-SS
Fork for gripping rolling tray for EU std Bins -150 kg	WPR-T-9023
Fork for gripping rolling tray for EU std Bins - 150 kg - SS	WPR-T-9023-SS
Articulated Core Gripper for wrapping reel - 50 kg	WPR-T-0025
Manual front tilting gripper for drums - 80 kg	WPR-T-9026
Manual front tilting gripper for drums - 80 kg - SS	WPR-T-9026-SS
Manual side tilting gripper for waste bin - Customizable - 80 kg	WPR-T-9027
Manual core gripper with tilting 90° for reel - core Ø 76 mm - 80 kg - SS	WPR-T-0028-SS
Extended manual core gripper with tilting 90° for reel - core Ø 76 mm - 80 kg - SS	WPR-T-0034-SS
Vertical core gripper for reel core Ø 76 mm - 80kg - SS	WPR-T-0029-SS
Electric core gripper with tilting 90° for reel core Ø 76 mm - 110kg - SS*	WPR-T-0030-SS
Electric clamp - 100 kg - SS*	WPR-T-0031-SS
Electric clamp with rotation system - 100 kg - SS*	WPR-T-0032-SS

ACCESSORIES	REFERENCE
Quick change tooling - trolley part - 205 kg - SS	WPR-A-0003-SS
Quick change tooling - tool part - 205 kg - SS	WPR-A-0004-SS
Tool attachment elevation - 150-500 mm	WPR-A-9005
Tool attachment elevation - 150-500 mm - SS	WPR-A-9005-SS
Lateral translator ± 200 mm	WPR-A-0006
Weighting system on crane - 200 kg	WPR-A-0007-SS
Height position marking	WPR-A-0008
Snap Hook Ø 6 - SS	WPR-A-0009-SS
Snap Hook Ø 8 - SS	WPR-A-0010-SS
Lifting chain - 1 m - SS	WPR-A-0011-SS
Safety shackle	WPR-A-0012
Safety shackle - SS	WPR-A-0012-SS
Latch hook	WPR-A-0013
Latch hook - SS	WPR-A-0013-SS
360° Latch hook	WPR-A-0014
Platform rollers Ø 50 mm with 2 fixation pieces SS	WPR-A-0015-SS
Platform edges - SS	WPR-A-0016-SS
Extension for expandable hub Ø 76 mm - SS	WPR-A-0017-SS
Core gripper adapter for reel with core Ø 150 mm	WPR-A-0018-SS
Adjustable Crane Crossbar 60 x 40 - 600 mm	WPR-A-0019
Adjustable Crane Crossbar 60 x 40 - Customizable	WPR-A-9019
Adjustable Crane Crossbar - 600 mm - SS	WPR-A-0019-SS
Adjustable crane crossbar - Customizable - SS	WPR-A-9019-SS
End stops on forks	WPR-A-0020
End stops on forks - SS	WPR-A-0020-SS
Short clamping jaws with 2 rollers*	WPR-A-0021-SS
Long clamping jaws with 2 rollers*	WPR-A-0022-SS
Articulated clamping jaws with 4 rollers*	WPR-A-0023-SS
Jaws with adapted form to bespoke diameter*	WPR-A-9024-SS
Manual rotation system - 100 kg - SS	WPR-A-0026-SS
Electric rotation System - 150 kg - SS*	WPR-A-0027-SS
Plate with indexing pin for 90° locking of the V platform.	WPR-A-0028-SS



WORK POSITIONER WP 285

DESCRIPTION



For challenging handling

The lift trolley WP 285 is intended for carrying heavy loads, it can lift, move or turn up to 285 kg. Particularly suitable for large manufacturers, it accompanies your employees for the transport of heavy reels, drums or any other type of load.

Customizable, it can be equipped with hand tools (booms, platforms, forks) or electrical tools (clamps, coil turners). It has a distinctive design from the other trolleys in its range. The WP 285 is equipped with a double mast with a transparent back frame to facilitate the user's view when moving. It is also equipped with an ErgoControl handle specially designed for this lift trolley.

This trolley is a good purchasing compromise, it can be used by all employees and does not require a special permit or training.

The model WP 285 has a total capacity of **285 kg**, at a distance of 400 mm from the mast.

The WP 285 is delivered with **Lithium batteries** (48 V ; 18 Ah) as standard.

The motor speed is **120 mm/s**.

TECHNICAL SPECIFICATIONS

DESCRIPTION	WP 285
Max capacity (kg)	285
Belt operating capacity (kg)	834
Belt breaking load (kg)	3230
Command type	Remote control
Battery type	1 Lithium 48 V - 18 Ah
Total battery weight (kg)	5,92
Charger	External - 200-240 V - 50-60Hz
Number of cycles	130 cycles
Battery indicator	On the remote control unit
Recharge time	2h for 100%
Front wheel	Simple Ø 80 - fixed
Rear wheel	Ø 160 - with individual brake

REFERENCE	TROLLEY	LENGTH OF LEGS	WIDTH OF LEGS	TOTAL HEIGHT	LIFTING STROKE	WEIGHT
WPR-285-3121	WP 285M-S-500	540	515	2000	1440	151
WPR-285-3131	WP 285M-S-650	690	515	2000	1440	152
WPR-285-3141	WP 285M-S-850	890	515	2000	1440	153

➤ LOAD DIAGRAM

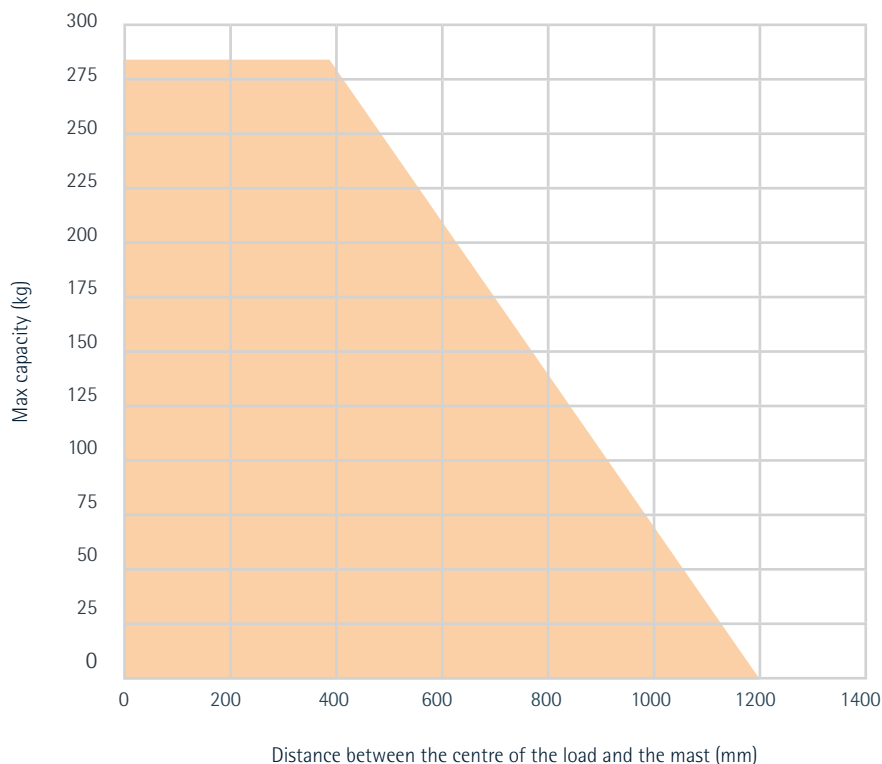

WORK POSITIONER WP 285

ORDERING INFORMATION

REMOTE CONTROL	REFERENCE
ERGOCONTROL handle with 1 button	WPR-RO
ERGOCONTROL handle Remote with function up and down	WPR-R1
ERGOCONTROL handle Remote with function up and down + option automatic level / positioner	WPR-R2
ERGOCONTROL handle Remote + clamping + tilting	WPR-R3
ERGOCONTROL handle Remote with function up and down + clamping + rotation	WPR-R4
ERGOCONTROL handle Remote with function up and down + rotation	WPR-R5
ERGOCONTROL handle Remote with function up and down + clamping	WPR-R6
ERGOCONTROL handle Remote with function up and down + tilting	WPR-R7

OPTIONS	REFERENCE
Automatic level option with unit cell in a casing	WPR-O-0001
Positioner system with multiple position	WPR-O-0002
1 Additional electric function*	WPR-O-0007
2 Additional electric functions*	WPR-O-0008
Special enlargement from 581 mm and more - WP 285	WPR-O-0015
Width reduction of the legs between standard and central legs width	WPR-O-0016
Mast height custom fit (between smallest & highest mast)*	WPR-O-0019

TOOLS	REFERENCE
Platform stainless steel - steel frame - 500 x 500 mm - 200 kg	WPR-T-0009
Platform stainless steel - steel frame - 200 kg - Customizable	WPR-T-9009
Platform stainless steel - stainless steel frame - 500 x 500 mm - 200 kg	WPR-T-0009-SS
Platform stainless steel - stainless steel frame - 200 kg - Customizable	WPR-T-9009-SS
Platform HDPE - steel frame - 500 x 500 mm - 200 kg	WPR-T-0013
Platform HDPE - stainless steel frame - 500 x 500 mm - 200 kg	WPR-T-0013-SS
Platform HDPE - steel frame - Customizable - 200 kg	WPR-T-9013
Platform HDPE - stainless steel frame - Customizable - 200 kg	WPR-T-9013-SS
Wave Platform with rollers - 160 kg	WPR-T-9039
Wave Platform with rollers - 160 kg - SS	WPR-T-9039-SS
Crane arm with adjustable hook support - 200 kg	WPR-T-0015
Crane arm with adjustable hook support - 180 kg - Customizable	WPR-T-9015
Crane arm with adjustable hook support - 200 kg - SS	WPR-T-0015-SS
Crane arm with adjustable hook support - 180 kg - Customizable - SS	WPR-T-9015-SS
Core gripper with electric 90° tilting for reel core Ø 76 mm - 200kg*	WPR-T-0037

ACCESSORIES	REFERENCE
Short clamping jaws with 2 rollers*	WPR-A-0021-SS
Long clamping jaws with 2 rollers*	WPR-A-0022-SS
Articulated clamping jaws with 4 rollers*	WPR-A-0023-SS
Jaws with adapted form to bespoke diameter*	WPR-A-9024-SS
Manual rotation system - 100 kg - SS	WPR-A-0026-SS
Electric rotation System - 120 kg - SS*	WPR-A-0027-SS



WORK POSITIONER WP 285 SS

DESCRIPTION



Stainless
Steel



For challenging handling

The WP 285 lift trolley is the largest handling trolley in the EdmoLift range which is also available in a full stainless steel version. It has a distinctive design from other trolleys, a double mast with a transparent back frame to facilitate the user's view. It is also equipped with an ErgoControl handle specially designed for this stacker.

The WP 285 handling trolley can lift, move and turn loads up to 285 kg (load + tool). This lift trolley can be equipped with various hand tools like platforms, booms or forks, also electrical tools like clamps or reel turners.

This trolley is a good purchasing compromise, it can be used by all employees and does not require a special permit or training. With the stainless-steel version, the WP 285 trolley can easily be used in the agri-food, chemical or pharmaceutical sectors.

The model WP 285 SS has a total capacity of **285 kg**, at a distance of 400 mm from the mast.

The WP 285 SS is delivered with **Lithium batteries** (48 V ; 12 Ah) as standard.

The motor speed is **120 mm/s**.

TECHNICAL SPECIFICATIONS

DESCRIPTION	WP 285 SS
Max capacity (kg)	285
Belt operating capacity (kg)	834
Belt breaking load (kg)	3230
Command type	Remote control
Battery type	1 Lithium 48 V - 18 Ah
Total battery weight (kg)	5,92
Charger	External - 200-240 V - 50-60Hz
Number of cycles	130 cycles
Battery indicator	On the remote control unit
Recharge time	2h for 100%
Front wheel	Simple Ø 80 - fixed
Rear wheel	Ø 160 - with individual brake

REFERENCE	TROLLEY	LENGTH OF LEGS	WIDTH OF LEGS	TOTAL HEIGHT	LIFTING STROKE	WEIGHT
WPR-285-3121-SS	WP 285M-SS-S-500	540	515	2000	1440	155
WPR-285-3131-SS	WP 285M-SS-S-650	690	515	2000	1440	156
WPR-285-3141-SS	WP 285M-SS-S-850	890	515	2000	1440	157

▶ LOAD DIAGRAM

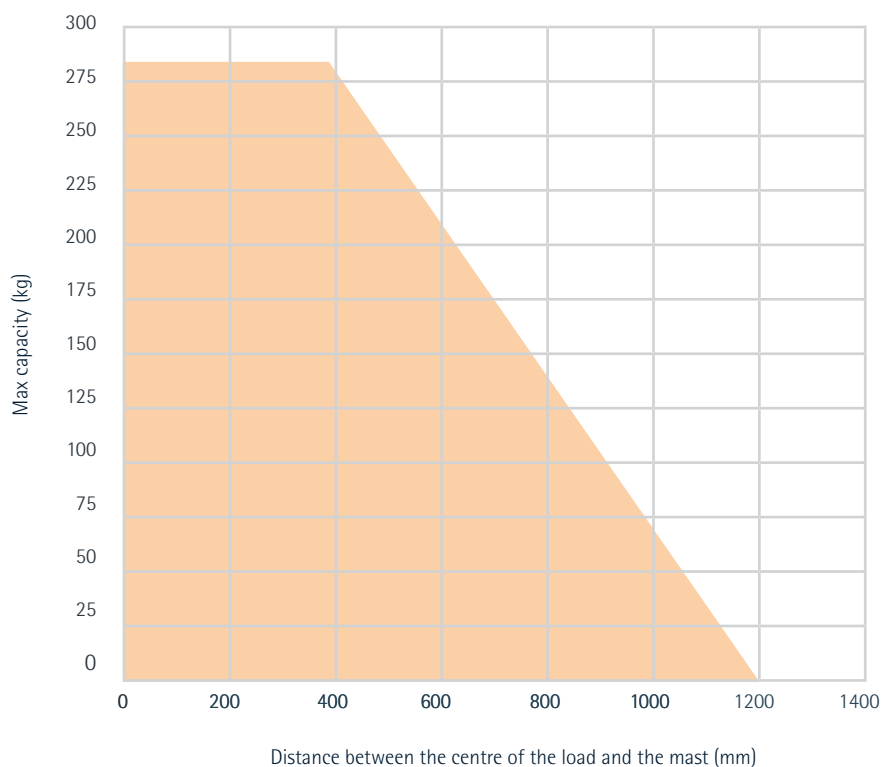

WORK POSITIONER WP 285 SS

ORDERING INFORMATION

REMOTE CONTROL	REFERENCE
ERGOCONTROL handle in stainless steel with 1 button	WPR-RO-SS
ERGOCONTROL handle Remote with function up and down	WPR-R1
ERGOCONTROL handle Remote with function up and down + option automatic level / positioner	WPR-R2
ERGOCONTROL handle Remote + clamping + tilting	WPR-R3
ERGOCONTROL handle Remote with function up and down + clamping + rotation	WPR-R4
ERGOCONTROL handle Remote with function up and down + rotation	WPR-R5
ERGOCONTROL handle Remote with function up and down + clamping	WPR-R6
ERGOCONTROL handle Remote with function up and down + tilting	WPR-R7

OPTIONS	REFERENCE
Automatic level option with unit cell in a casing	WPR-O-0001
Positioner system with multiple position	WPR-O-0002
1 Additional electric function*	WPR-O-0007
2 Additional electric functions*	WPR-O-0008
Special enlargement from 581 mm and more - WP 285	WPR-O-0015
Width reduction of the legs between standard and central legs width	WPR-O-0016
Max height custom fit (between smallest & highest mast)*	WPR-O-0019

TOOLS	REFERENCE
Platform stainless steel - steel frame - 500 x 500 mm - 200 kg	WPR-T-0009
Platform stainless steel - steel frame - 200 kg - Customizable	WPR-T-9009
Platform stainless steel - stainless steel frame - 500 x 500 mm - 200 kg	WPR-T-0009-SS
Platform stainless steel - stainless steel frame - 200 kg - Customizable	WPR-T-9009-SS
Platform HDPE - steel frame - 500 x 500 mm - 200 kg	WPR-T-0013
Platform HDPE - stainless steel frame - 500 x 500 mm - 200 kg	WPR-T-0013-SS
Platform HDPE - steel frame - Customizable - 200 kg	WPR-T-9013
Platform HDPE - stainless steel frame - Customizable - 200 kg	WPR-T-9013-SS
Wave Platform with rollers - 160 kg	WPR-T-9039
Wave Platform with rollers - 160 kg - SS	WPR-T-9039-SS
Crane arm with adjustable hook support - 200 kg	WPR-T-0015
Crane arm with adjustable hook support - 180 kg - Customizable	WPR-T-9015
Crane arm with adjustable hook support - 200 kg - SS	WPR-T-0015-SS
Crane arm with adjustable hook support - 180 kg - Customizable - SS	WPR-T-9015-SS
Core gripper with electric 90° tilting for reel core Ø 76 mm - 200kg*	WPR-T-0037

ACCESSORIES	REFERENCE
Short clamping jaws with 2 rollers*	WPR-A-0021-SS
Long clamping jaws with 2 rollers*	WPR-A-0022-SS
Articulated clamping jaws with 4 rollers*	WPR-A-0023-SS
Jaws with adapted form to bespoke diameter*	WPR-A-9024-SS



WP 125

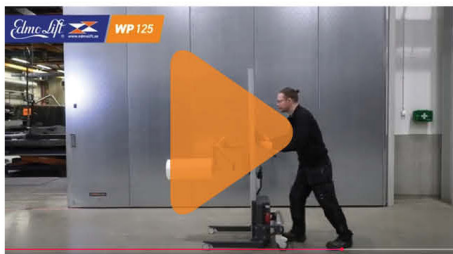

SCAN CODE

WORK POSITIONERS



© 02-2025 REGLIFT - All rights reserved. Any total or partial reproduction of this document, without the express authorisation of REGLIFT, is prohibited.

REV 2025.2



+46 (0)611-36 87 00
b2b@edmolift.se
www.edmolift.se

EdmoLift AB
Jägaregatan 11
871 42 Härnösand
Sweden

